

STEERING

Overview

This section will address those parts of the steering system related to the:

- Steering wheel
- Steering column
- Power steering fluid requirements
- Steering gear (TAS 55)
- Hydraulic steering pump
- Pitman
- Drag link
- Tie rod (cross tube)
- Tie rod ends
- Lubrication requirements

Appendixes In This Chapter

Appendix 1. TAS Steering Gear (Exerpt). This four page exerpt from TRW's Steering Gear Service Manual includes fluid information, an exploded parts diagram, and torque specifications for the TAS55 steering gear.

Appendix 2. Popped Adjustment. This four page TRW Service Bulletin explains on-vehicle poppet readjustment procedure.

Appendix 3. TRW Steering Maintenance. This TRW publication, entitled *Chart Your Way To Easy Steering*, provides a solid overview of potential steering problems, their diagnosis and correction.

WARNING *Hydraulic fluid must be handled, stored and disposed of in a manner consistent with all the applicable local, state, and federal guidelines concerning hazardous materials.*

The hydraulic pump for the power assist is located on the engine. The configuration of piping from the pump to the steering gear is dependent on whether the bus has hydraulic brakes or an air brake system.

On Visions equipped with air brakes, the power steering fluid flows to the steering gear, and returns directly to the reservoir. On Visions equipped with hydraulic brakes, the power steering fluid flows from the reservoir into the power steering gear. The pressurized fluid is then directed to the hydraulic brake power assist (booster). From there, the power steering fluid is returned to the reservoir, under lower pressure.

Torque from the steering wheel is transmitted through the steering column to the steering gear. The TAS 55 steering gear assists the efforts of the driver.

CAUTION *The power steering fluid and the brake fluid are not the same. They must be kept separate. Use DOT-3 for the brake system and use Dexron III for the power steering fluid.*

Other oils are acceptable for the power steering system; however, the system must be drained and flushed to use any of these. (See the appropriate TRW Service Manual for a complete list.) Do not mix oils or fluids if you change the fluid.

The reservoirs are mounted on the firewall, near the steering column. The brake reservoir has two filler caps, and stands away from the firewall due to the electrically operated emergency brake boost pump assembly.

Steering System Maintenance

Before attempting to work on the steering gear, or any portion of the steering system, you must stabilize the vehicle. Read and understand the Warnings and Cautions in the General Maintenance chapter of this manual.

Regularly check the fluid level in the power steering reservoir. Change the fluid and replace the filter at the intervals specified in the Specs & Maintenance chapter. Clean around the reservoir filler cap before removing it. Dirt and other foreign matter can damage the hydraulic system.

Do not bend or straighten any steering component or linkage. Never attempt to weld any broken steering component. Do not use a torch to remove any steering component. Use only original equipment replacement parts.

Never use high pressure or steam to clean the power steering gear while on or off the bus. Doing so can force contaminants inside the gear and lead to malfunction.

Proper alignment of the steering column is important to assure smooth steering. Correct the cause of any free play, rattle, or shimmy immediately to avoid damage to the steering system. Record and report any malfunctions or accidents which may have damaged steering components.

Axle Stop Adjustment

Adjustment of the axle stops should be made after tow-in has been set on the front axle.

1. With the front tires on turn-angle plates, center the left front tire in the straight ahead position using alignment equipment, then set the turn-angle plates to zero.
2. Set the axle stops to allow 50° of full right and full left steerage. Check for adequate clearance between tires and wheelwells. Lock the axle stop jam nuts after adjusting the axle stops.
3. Remove the turn-angle plates. Verify that the axle stops contact the axle pads at full right-hand and left-hand turns. It may be necessary to relieve tire flex by rolling the bus forward or backward, in order to make the axle stops contact. There must be at least ¼-inch clearance between the pitman arm, drag rod and front axle tie rod, and all potential interference points.

Setting the Steering Poppets

To adjust the steering poppets, refer to Appendix 2 in this chapter.

Toe-In Adjustment

Set the toe in with no weight in the bus. The curb weight of the vehicle should be on the ground. Toe should be checked at the tires front and rear center, at a distance above the ground equal to the rolling radius of the tires. The toe must be $\frac{1}{16} \pm \frac{1}{32}$ (.06" \pm .03").

1. Adjust the toe by turning the tie rod cross tube.
2. When the correct toe is achieved, tighten the pinch bolts at the tie rod ends.
Torque the pinch bolts to 50–60 ft. lbs. (67.79–81.35 Nm).

Steering Lubrication Points

Use NLGI #2 EP and greases rated GC–LB, or equivalent. Refer to the Specs & Maintenance chapter for service intervals.

- The steering gear. (Use only hand grease gun to lube the steering gear.)
- Both ends of the draglink.
- Top and bottom of the King-pin.
- Both ends of the tie-rod.
- The slack adjuster.
- The cam brake housing.

King-Pin Lubrication

The suspension must be loaded prior to lubrication. Either place the bus on the ground or lift by the wheels; not the axles.

1. Clean off all the grease fittings with clean shop towel prior to lubrication.
2. Lubricate the King pins through the fittings at the top and bottom of the King pin.
3. Force the proper lubricant into the upper and lower grease fittings until grease flows from the purge locations. Greasing at the lower zerk should purge lubricant from the thrust bearing shell. The right hand side (curb side) of the axle has a steel roller thrust bearing; the left hand side has a composite thrust bearing. Both purge in the same area.

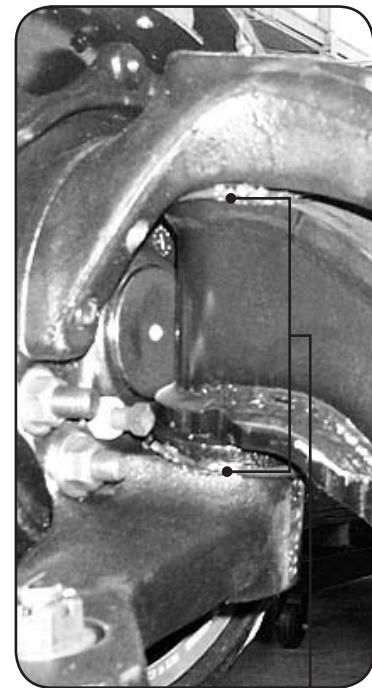

King Pin Grease Purge Locations

Tie-Rod Lubrication

1. Turn the bus wheels straight ahead.
2. Clean the zerk fittings at each end.

3. Wipe the seal/boot clean as well.
4. Attach a grease gun to the zerk fitting. Either a hand or air operated grease gun may be used. If an air operated grease gun is used, the system air pressure should not exceed 150 psi (1035 kPa).

CAUTION Exceeding the maximum air pressure specification, can cause damage to the dust boot, leading to premature component failure.

If the Rod-end will not accept lubricant:

- 4.1 Remove the zerk fitting.
 - 4.2 Inspect the threaded zerk fitting hole in the tie-rod end and remove any obstructions.
 - 4.3 Install a new zerk fitting if necessary.
 - 4.4 When the fitting accepts lubrication as required, continue with the procedure.
5. If the tie rod will not accept grease after replacing the zerk fitting, the tie rod end must be replaced. Refer to the Tie Rod section in this chapter, and to the Hendrickson SteerTek manual which is included as an appendix in the Front Axle & Suspension chapter.
 6. Continue to lubricate until all fittings in the steering system are purged of old grease.

Steering Wheel & Switches

Steering Wheel & Switch Removal

The hub of the steering column contains the horn connection, the turn signal self cancel mechanism, the dimmer switch for the headlights and the hazard flasher switch. To access these components, it is necessary to remove the steering wheel.

1. Using a small thin tool, such as small screwdriver, carefully remove the horn button from the center of the steering wheel.
2. Remove the large hexnut securing the steering wheel to the steering column.
3. Using a wheel puller of the proper size and shape, remove the steering wheel.
4. Remove the four, 1/4-inch, hexhead screws.

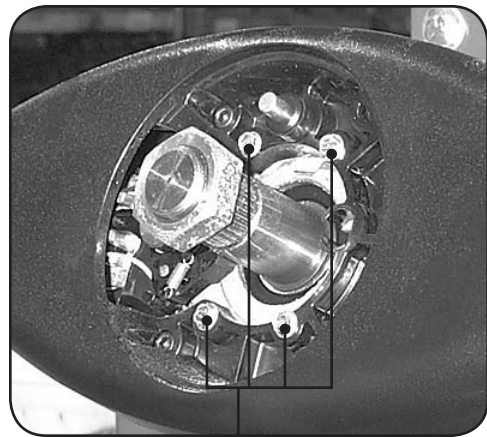

Steering column housing screws



5. Using a small thin tool, carefully separate the two pieces of the steering column housing. Be very careful to avoid breaking the wires.
6. Remove the grounding wire from the lower steering column hub.
7. Disconnect the wiring harness from the switch.
8. Remove two screws from the underside of the hub and carefully remove the switch assembly. It is recommended that the whole switch assembly be replaced, not repaired. Contact Blue Bird Parts Sales, or your Blue Bird Distributor, for replacement information.

Steering Wheel & Switch Reinstallation

To replace the switch/wheel assembly, reverse the procedure above.

1. Replace the ¼-inch hexhead screws that secure the switch assembly to the steering column assembly. Torque them to 2–4 ft. lbs. (2.71–5.42 Nm).
2. Connect the wiring harness to the switch.
3. Position the top section of the steering column housing over the lower section and snap into place.
4. Install the four ¼-inch hexhead screws. Torque them to 2–4 ft. lbs. (2.71–5.42 Nm).
 - Ensure the turn indicator lever operates in the normal manner.
 - Check the hazard flasher operation.
 - Check the Headlight dimmer toggle switch for proper operation.
5. Ensure that the front wheels are pointed straight ahead.
6. Ensure the steering wheel is positioned properly.
7. Press the hub of the steering wheel into position over the spline at the end of the steering column shaft.
8. Install the retainer nut at the end of the steering shaft. Torque to 55–65 ft. lbs. (75.57–88.13 Nm). If the threaded end of the steering shaft is not flush with the nut; remove the nut, clean the threads of the nut and the shaft. Then apply 3 drops of Loctite™ (242 blue) or equivalent, and install and torque the nut.

Steering Column & Intermediate Steering Shaft

Steering Column Removal

1. Remove the pinch bolt securing the steering column shaft to the intermediate steering shaft assembly, and collapse the shaft to separate the assembly.
2. Remove the lower four nuts securing the steering column assembly to the firewall, inside the bus.
3. Disconnect the three harness connectors located behind the dash above the steering shaft housing.
4. Remove the four upper bolts and nuts securing the steering column to the under side of the dash.

For questions regarding the repair of the steering column assembly, refer to the appropriate Ross service manual.

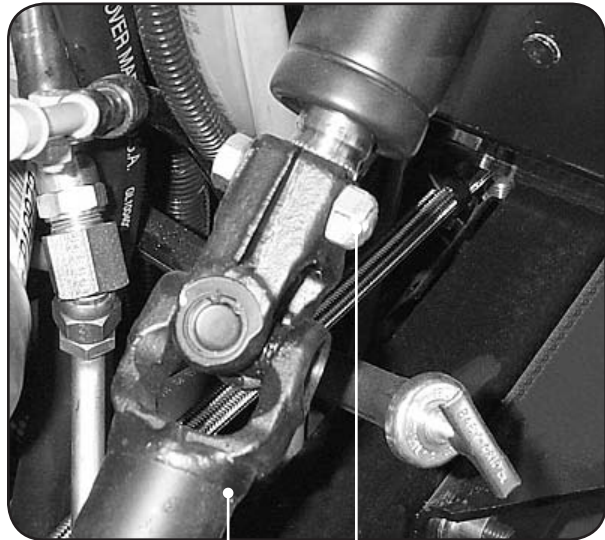

Pinch bolt
Intermediate Steering Shaft

Steering Column Reinstallation

1. Position the steering column assembly so that the four bolts and nuts that secure the column to the dash mounting bracket can be loosely installed.
2. The installation procedure is now essentially the reverse order of the removal steps above, with the exception that the wiring harness should not be connected until the last step to avoid possible damage.
3. Torque the four nuts at the firewall to 2–4 ft. lbs. (2.71–5.42 Nm).
4. Torque the four 3/8 bolts securing the steering column to the dash to 10–15 ft. lbs. (13.56–20.34 Nm).
5. Slide the intermediate steering shaft assembly into position. Torque a new cad/wax locknut to 40.32–43.68 ft. lbs. (54.66–59.22 Nm).

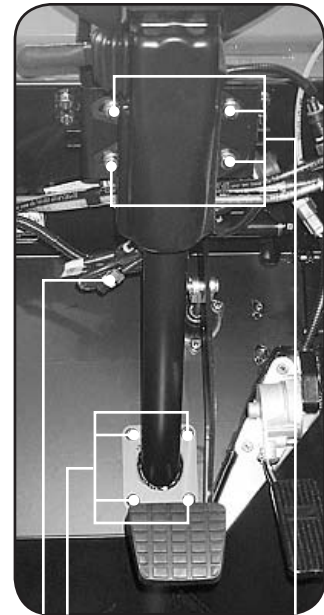

Lower Column Mount Bolts
Upper Column Mount Bolts
Harness Connector

Intermediate Steering Shaft Removal

To remove the intermediate (telescoping) steering shaft:

1. Remove the 7/16 bolt at the steering column end of the shaft.
2. Remove the 7/16 bolt at the steering gear end of the shaft.
3. Collapse the shaft to remove it from the spline at each end.



Steering Gear

The TAS 55 is an integral hydraulic power steering unit. The steering gear contains a manual steering mechanism, a hydraulic control valve, and a hydraulic power cylinder. The control valve senses the steering gear requirements and directs fluid to the appropriate cylinder cavity at the proper flow rate and pressure.

The speed at which the driver can turn the steering wheel with power assist is dependent upon the rate of flow provided by the hydraulic pump. (Minimum flow rate is 2.6 gpm.) As the driver turns the steering wheel faster or slower, more or less fluid is required by the gear. The pressure of the hydraulic fluid is used to overcome the resistance at the tires. The higher the pressure, the more work it can perform. (Maximum operating pressure is 2,175 psi.)

The steering gear is connected to the steering gear input shaft. The input shaft is connected to a worm shaft. When the driver turns the steering wheel, the input shaft and worm shaft rotate. The worm shaft is in turn connected to a rack piston through the recirculating ball mechanism. This rotational movement moves the rack piston axially in the gear housing cylinder bore. The rack piston turns the sector shaft, which is connected by linkage to the steering wheels.

Pressurized fluid assists the movement of the rack piston, reducing the effort needed to steer the bus. As the input shaft is turned, the control valve spool mounted on the torsion shaft (the torsion shaft connects the input shaft to the worm shaft) shifts and sends pressurized fluid to either side of the rack piston. A relief valve, mounted on the valve housing, limits maximum supply pressure to protect the power steering gear. This is the primary pressure protection for the steering system. (A secondary pressure relief valve is located in the hydraulic pump assembly.)

Objectionable kickback is prevented due to the geometry of the steering gear. If the wheels receive a shock load, it is transmitted back through the sector shaft, rack piston, and worm gears. This load is neutralized by the control valve, which sends high pressure fluid to the correct side of the rack piston to resist the shock forces. By absorbing the shock forces hydraulically, the steering gear prevents objectionable kickback at the steering wheel.

The steering gear is equipped with two poppet valves, one on each side of the rack piston. The poppet valves are set to the axle stops, after axle stop adjustment has been made. When the steering wheels are turned and approach the axle stop, one poppet valve (depending on the direction of turn) trips. The tripped poppet valve opens, allowing fluid to pass the piston, which reduces pressure in the gear and helps reduce heat generated by the pump. At the same time, the valves also reduce forces on the steering linkage.

Careful preliminary checks should be done to identify a steering problem and its symptoms before deciding to tear down the steering gear. In most cases, the steering gear should be the last component suspected as cause of a steering problem.

Steering Gear Removal

It is not necessary to completely remove the intermediate steering shaft to remove the steering gear.

- 1 Ensure the front wheels are straight ahead.
- 2 Exercise care that all applicable local, state and federal laws are observed, and drain the power steering fluid (Dexron III) into an acceptable container for disposal.
3. Remove the $\frac{7}{16}$ bolt from the steering gear end of the intermediate steering shaft coupler.
4. Separate the intermediate steering shaft from the steering gear, and then secure it safely out of the way.
5. Remove the hydraulic hoses. Be sure to note which hose is installed at which port on the steering gear, for installation. Be ready to contain hydraulic fluid escaping as the hose fittings are opened and removed.
6. Remove the cotter pin and the castle nut at the lower (drag link) end of the Pitman arm. Discard the cotter pin. Secure the drag link in a manner to protect the journal surface.

WARNING Proper support is required to continue these instructions. The steering gear may weigh as much as 110 pounds (49.895 kg).

6. Remove the 3 mounting bolts from the steering gear. Notice that the forward top bolt is inside and forward of the front crossmember. Do not remove the 2 smaller bolts near this position.

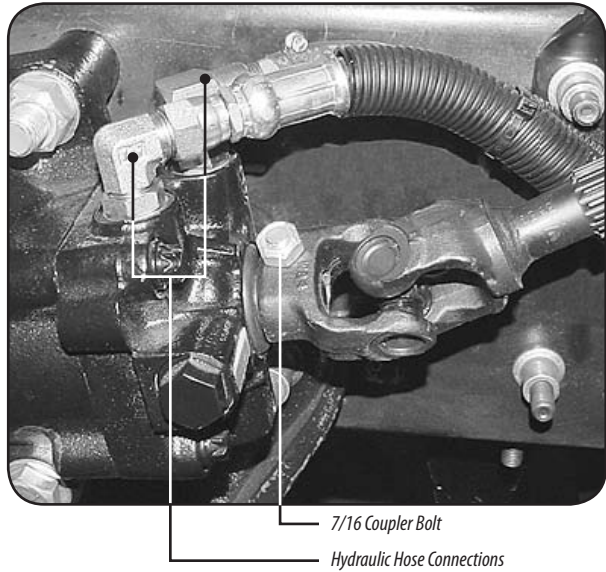

7/16 Coupler Bolt
Hydraulic Hose Connections

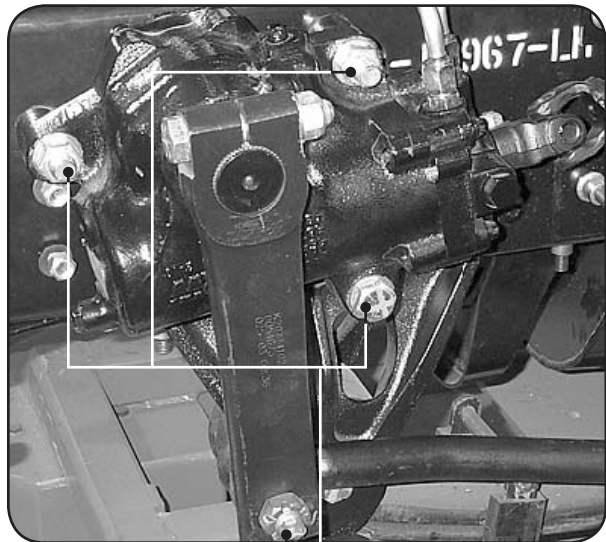

Steering Gear Mounting Bolts
Castle Nut & Cotter Pin

Steering Gear Reinstallation

Installation of the steering gear is accomplished in the reverse order of removal. Always use new hardware when installing steering assembly components. Be sure the long mounting bolt, Blue Bird Part Number 0059401 ($\frac{3}{4}$ -10 X $6\frac{1}{4}$), is installed at the bottom-center position. The top mounting bolts are Blue Bird Part Number 1021815 ($\frac{3}{4}$ -10 X $4\frac{1}{2}$). These bolts are Grade 8 and the locknuts are Cad/Wax. The flat washers must be hardened as well. Contact your Blue Bird distributor for replacement hardware.

The top mounting bolts (the shorter ones) should be installed with the bolt hexhead inside the frame rails. The bottom-center bolt should be installed with the bolt hex-head outside the frame rails. Torque the mounting bolts to 250–282 ft. lbs. (339–382 Nm).



Carefully thread the hydraulic fittings to the proper port. Installing them incorrectly will cause damage to the steering gear and, possibly, the hydraulic pump. Tighten the flare fittings to 1½ turns past finger tight. Ensure that the fitting is held at the hex flats as the fittings are tightened. Do not apply excessive torque to the fitting to steering gear connection. There is an “O” ring in the connection. Route, and secure, all hoses and tubing to provide at least ½ inch clearance from any moving part.

Pitman Arm

Pitman Arm Removal

Remove the Pitman arm end of the draglink and secure it safely out of the way. Then remove and discard the nut and bolt assembly from the upper end of the Pitman. Being very careful of the spline on the steering gear, remove the Pitman arm by pulling with a wheel puller.

Pitman Arm Installation

1. Position the Pitman arm so that the index mark aligns with the mark on the output spline of the steering gear.
2. The Pitman arm offset must be inward, and at the bottom.
3. Press the Pitman onto the output spline of the steering gear.
4. Install new hardware (¾–10 Grade 8), and torque to 250–282 ft. lbs. (339–382 Nm).
5. Attach the drag link to the Pitman arm. Position the drag link journal into the lower hole in the Pitman. Torque the castle nut to 110–125 ft. lbs. (149.14–169.48 Nm), then align a castle nut slot with the cotter pin hole. If necessary, tighten further just enough to align. Install a new cotter pin and bend each end at least 45° to hold it in position.

Drag Link

Drag Link Removal

1. Remove and discard the cotter pin from the castle nut on the each end of the drag link.
2. Remove the castle nut from the Pitman arm end and secure the drag link.
3. Remove the castle nut from the axle end of the drag link, and then remove the drag link journal from the Pitman arm. Be sure to wrap and protect the journal surfaces of the draglink.

Drag Link Reinstallation

Ensure the bend in the drag link is toward the front of the vehicle. Installation then becomes the reversal of the removal instructions, above. Torque each castle nut to 110–125 ft. lbs. (149.14–169.48 Nm), then align a castle nut slot with the cotter pin hole. Tighten further just enough to align if necessary. Install a new cotter pin and bend each end at least 45° to hold it in position.

Refer to the Hendrickson™ SteerTek service manual included as an appendix to the Front Axle & Steering chapter for further information regarding removal and installation of steering axle suspension components. Additional information is available at Hendrickson's website at www.hendrickson-intl.com.

Tie Rods

Tie Rod Assembly Removal

If the boot on the tie rod end is damaged, replace the tie rod.

1. Position the steer axle straight ahead.
2. Remove and discard the cotter pins from the castle nuts on the tie-rod knuckles.
3. Support the tie rod cross tube and remove the castle nuts.
4. Lightly tap on the side of the steering knuckle arm to loosen the tie rod end from the Ackerman arm.
5. Remove and discard the boot.

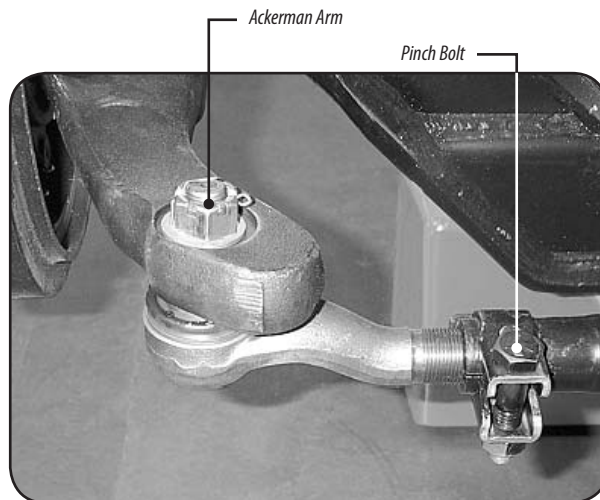

Tie Rod Assembly Installation

Installation is performed in the reverse order of the removal instructions, above.

1. Place a new boot on the tie rod end.
2. Install the tie rod journal into the Ackerman arm.
3. Torque the castle nuts to 185 ft. lbs. (250.83 Nm).
4. After torque value is achieved, tighten further just enough to align a castle nut slot and the cotter pin hole in the tie rod journal.
5. Install a new cotter pin. Bend each leg of the cotter pin at least 45°.

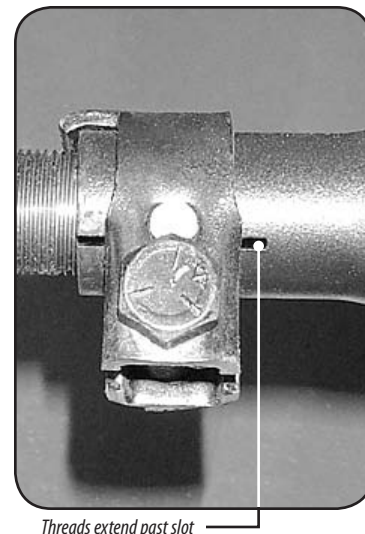



Tie Rod End Removal

1. Remove the desired tie rod from the steering knuckle in accordance with the instructions above, Tie Rod Assembly Removal.
2. Loosen the pinch bolt.
3. Count the turns (threads) as you remove the tie rod end from the cross tube.

Tie Rod End Installation

1. Apply anti-seize compound to the threads.
2. Install the tie rod end into the cross tube the same number of turns counted during disassembly.

WARNING *It is critical that the threaded portion of the tie rod end extends past the slots in the tie rod cross tube.*

3. Assemble the opposite end of the cross tube assembly, if necessary.
4. Apply NLGI #2 EP grease to the journals.
5. Install the tie rod end journal into the Ackerman arm. Keep the threads dry.
6. Install the dry castle nut onto the threads of the tie rod journal. Do not lubricate the threads.
7. Torque to 185 ft. lbs. (250.83 Nm).
8. Tighten further, enough to install a new cotter pin.
9. Bend each leg of the cotter pin at least 45° to hold it in position.
10. Lubricate the tie rod ends with NLGI #2 EP grease. Force lubricant into the zerk until all the air is purged.
11. Proceed with the toe-in adjustment before tightening the pinch bolts at the tie rods.

Steering Pump

The hydraulic pump on the Blue Bird Vision is a TRW™ PS221616L11301 if the unit has air brakes or PS221616L21301 with hydraulic brakes.

When troubleshooting, it is important to remember to always do the simple steps first. Look for obvious signs of leaking, component wear or damage, and hose problems, before removing the power steering pump.

Using a flow meter, determine whether the pump is providing the necessary flow. The steering pump should provide a flow of at least 2.6 gallons per minute (GPM). It is recommended that you use a Power Steering System Analyzer (PSSA) to assist in the diagnosis of steering system problems.

For details on troubleshooting the steering system, see **Appendix 3** in this chapter.

Steering Pump Removal (Vision With Air Brakes)

1. Drain the system of fluid in a manner consistent with all local, state and federal laws. Wear protective gear when working with hydraulic fluids including eye protection.
2. Remove the supply hose (17).
3. Remove the pressure line (16) from the fitting (18) at the output port of the pump.
4. Secure the pressure line safely out of the way.
5. Remove two M10 capscrews from the hydraulic pump mounting flange.
6. Remove and discard the gasket. (Blue Bird Part Number 1360411, Gasket Hydraulic Pump).

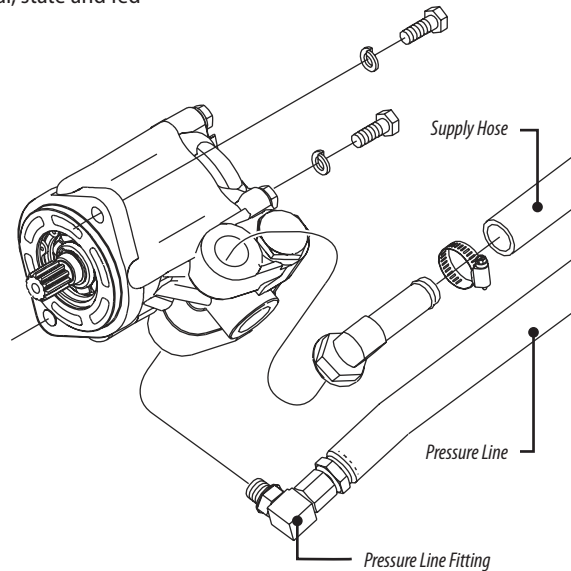

Steering Pump Reinstallation (Vision With Air Brakes)

Installation is accomplished in the reverse order of the removal instructions. Always install a new hydraulic pump gasket (Blue Bird Part Number 1360411). Also install a new split ring lock washer and torque the mounting capscrews to 53–58 ft. lbs. (71.86–78.64 Nm).

Ensure the system is full of fluid before starting the engine. After filling the reservoir, start the engine and turn the steering wheel one direction and then the other direction a couple of times; then stop the engine and fill the reservoir. Perform this cycle until the system remains full.

Test drive the bus and let the power steering fluid warm to operating temperature; then check the fluid level again. Check for leaks in the system.



Steering Pump Removal (Vision With Hydraulic Brakes)

1. Drain the system of fluid in a manner consistent with all local, state and federal laws. Wear protective gear when working with hydraulic fluids including eye protection.
2. Remove the supply hose.
3. Remove the pressure line from the fitting at the output port of the pump.
4. Secure the pressure line safely out of the way.
5. Remove two $\frac{3}{8}$ Grade 8 capscrews from the hydraulic pump mounting flange.
6. Remove and discard the o-ring. (Blue Bird Part Number 0064251).

Steering Pump Reinstallation (Vision With Hydraulic Brakes)

Install the pump in the reverse order of the removal. Ensure that a new o-ring is installed (Blue Bird Part Number 0064251). Install a new split ring lock washer and torque the mounting capscrews to 29–33 ft. lbs. (33.32–44.74 Nm).

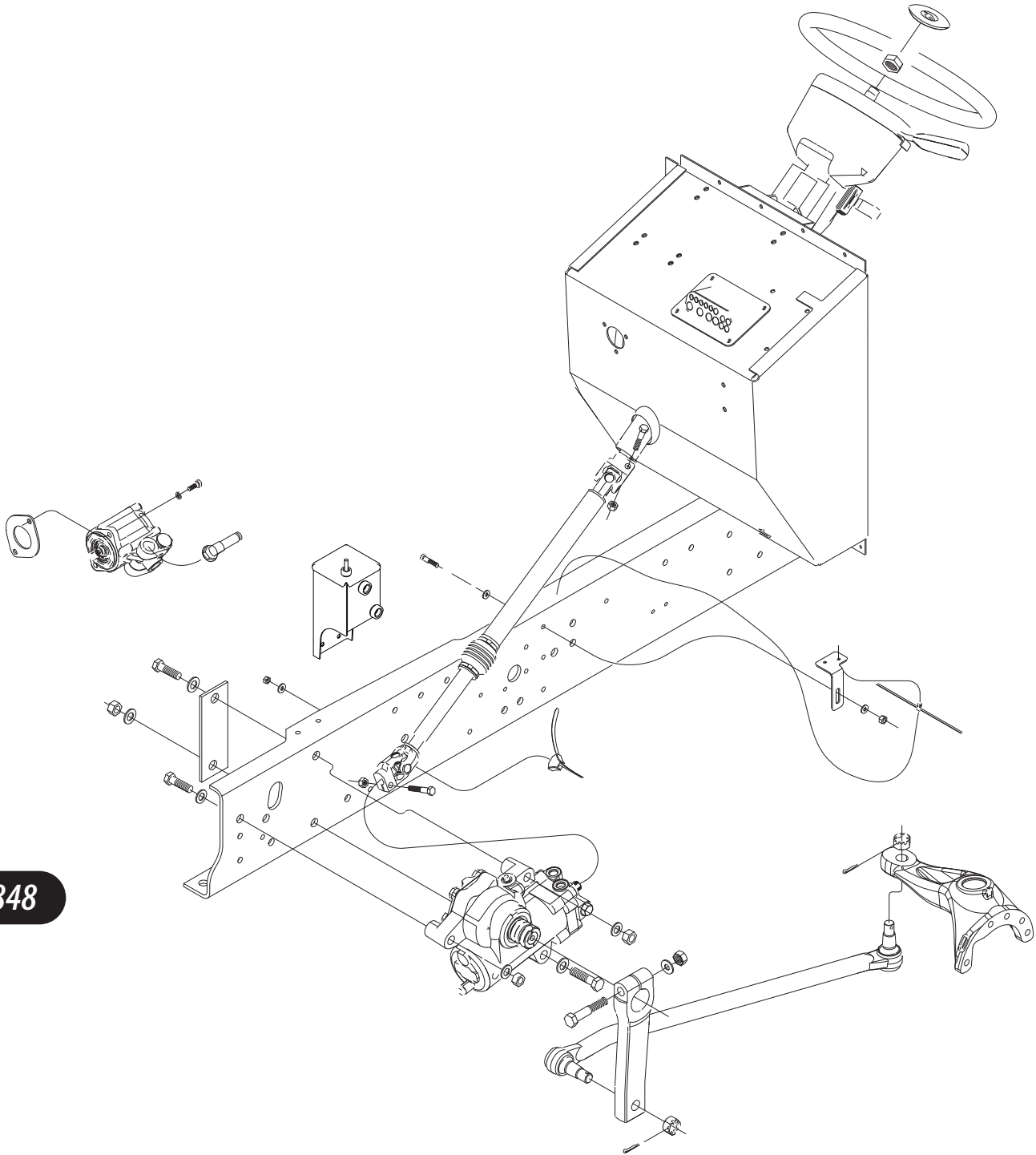

848

Steering Linkage

& Hydraulic Components

0054670K



Approved Hydraulic Fluids

Automatic Transmission Fluid Dexron II
 Automatic Transmission Fluid Type "E" or "F"
 Chevron 10W-40
 Chevron Custom 10W-40 Motor Oil
 Chevron Torque 5 Fluid
 Exxon Nuto H32 Hydraulic Fluid
 Fleetrite PSF (Can #990625C2)
 Ford Spec. M2C138CJ
 Mack EO-K2 Engine Oil

Mobil ATF 210
 Mobil Super 10W-40 Motor Oil
 Premium Blue 2000 - SAE 15W-40
 *Shell Rotella T30W
 *Shell Rotella T SAE 30
 Texaco 10W-40
 Texaco TL-1833 Power Steering Fluid
 Union 10W-40
 Union 15W-40
 Unocal Guardol 15W-40 Motor Oil

The steering system should be kept filled with one of the above fluids. Fluids marked with an asterisk (*) have not been approved for use with TRW's pump.

⚠ WARNING Completely flush the steering system with one of the recommended fluids above only. Do not mix oil types. Any mixture or any unapproved oil could lead to seal deterioration and leaks. A leak could ultimately cause the loss of fluid, which could result in a loss of power steering assist.

Specification Numbers

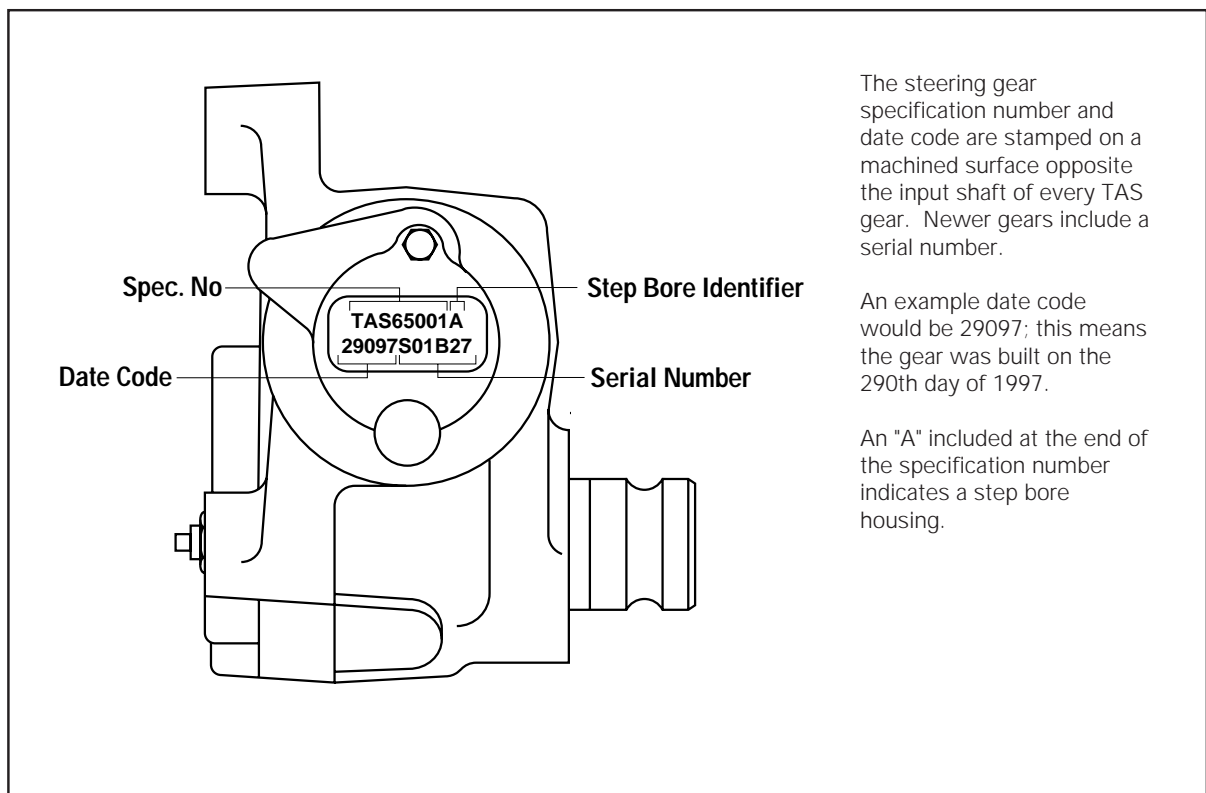

The steering gear specification number and date code are stamped on a machined surface opposite the input shaft of every TAS gear. Newer gears include a serial number.

An example date code would be 29097; this means the gear was built on the 290th day of 1997.

An "A" included at the end of the specification number indicates a step bore housing.

Torque Chart

Part Name	Item #	Torque Range Dry	Torque Range Lubricated
Auxiliary cylinder plug	54	25-35 lbf•ft (34-48 N•m)	
Ball return guide cap/strap bolts	31	14-22 lbf•ft (19-29 N•m)	
Bearing adjuster	17		11-15 lbf•ft (15-20 N•m)*
Locknut	18		101-122 lbf•ft (137-165 N•m)**
Manual bleed screw	50	40-50 lbf•in. (3.1-3.7 N•m)	
Plug, auto bleed	51	38-58 lbf•ft (52-79 N•m)	
Poppet sleeve assembly	22	16-20 lbf•ft (22-27 N•m)	
Poppet sealing nut, service	60	33-37 lbf•ft (45-50 N•m)	
Poppet fixed stop screw	52	38-42 lbf•ft (52-57 N•m)	
Poppet fixed stop screw	52A	38-58 lbf•ft (52-79 N•m)	
Relief valve cap	56	25-35 lbf•ft (34-48 N•m)	
Sector shaft adjusting screw jam nut	47	40-45 lbf•ft (54-61 N•m)	
Side cover bolts (TAS40)	48		108-128 lbf•ft (147-174 N•m)
Side cover bolts (TAS55, 65, 85)	48		160-180 lbf•ft (217-244 N•m)
Valve housing bolts (TAS40, 55, 65)	1		75-85 lbf•ft (102-115 N•m)
Valve housing bolts (TAS85)	1		108-128 lbf•ft (147-174 N•m)

Item numbers referenced are shown on the exploded views, pages 13 and 15.

Special tools can be purchased through:

SPX Corporation
 Kent-Moore Tool Group
 28635 Mound Road
 Warren, MI 48092
 1-800-328-6657

* After tightening to this torque value, the adjuster must be backed off ¼ to ½ of a turn as described in step 22 on page 61.

** Torque value indicated is using recommended tools.



TAS Series Exploded View -- Standard

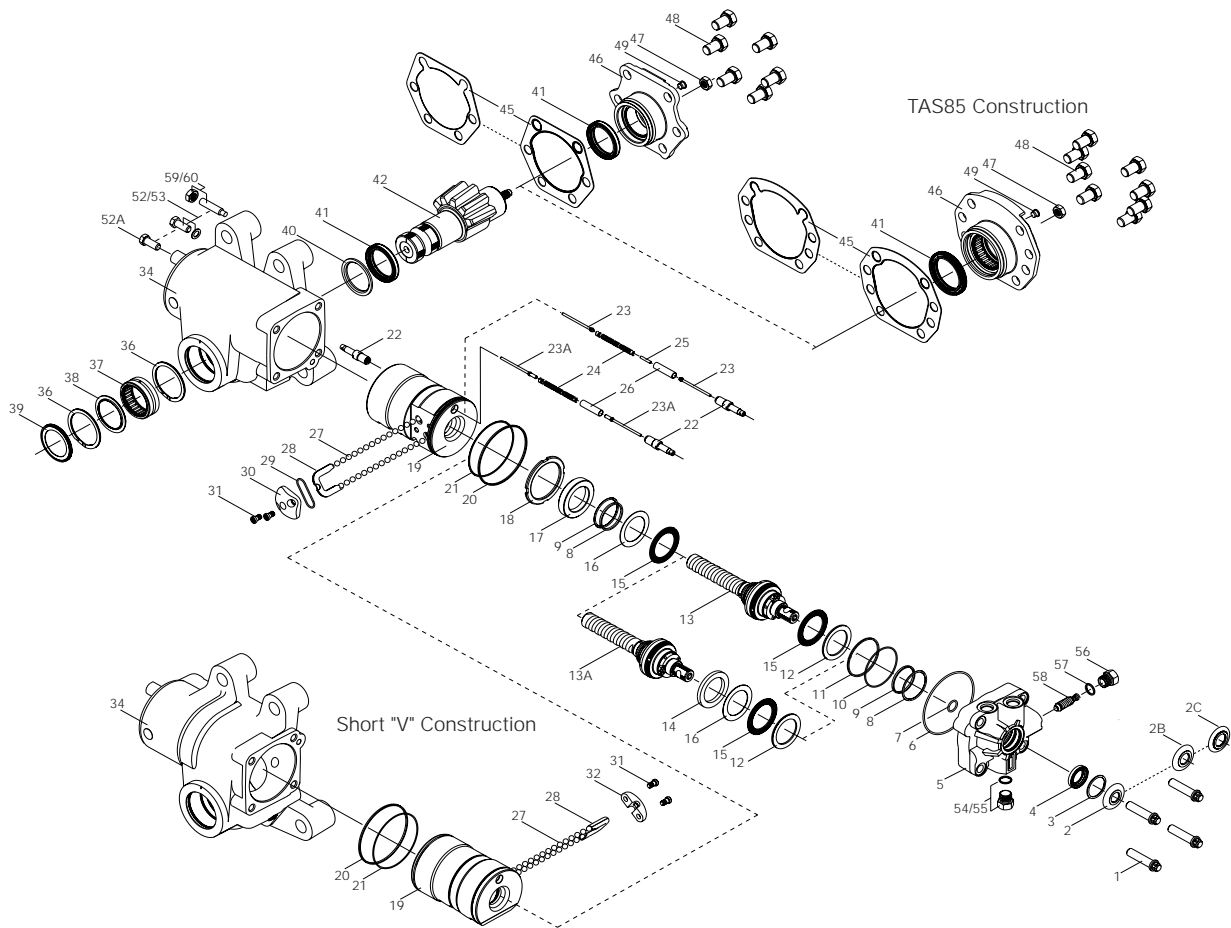

Item Description

- | | | |
|---|-------------------------------------|--------------------------------------|
| 1 Bolts (4-Valve Housing) | 16 Thrust Washer (Thin) | 36 Retaining Ring (2) |
| *2 Dirt and Water Seal 13/16" Serr. | 17 Bearing Adjuster | 37 Roller Bearing |
| *2B Dirt and Water Seal 7/8" Serr. | *18 Adjuster Locknut | *38 Dirt Seal |
| *2C Dirt and Water Seal 1" Serr. | 19 Rack Piston | *39 Dirt and Water Seal (Trunnion) |
| *3 Retaining Ring | *20 Teflon Seal Ring | 40 Washer (Spacer) |
| *4 Seal (Input Shaft) | *21 O-ring (Back up; Rack Piston) | *41 Seal (2-Output) |
| 5 Valve Housing | 22 Poppet Seat and Sleeve Assy. (2) | 42 Sector Shaft |
| *6 Seal Ring (Valve Housing) | 23 Poppet (2) | 43 Adjusting Screw (Sector Shaft) |
| *7 Seal Ring (Valve Housing) | 24 Poppet Spring | 44 Retainer (Adjusting Screw) |
| *8 Seal Ring (2) | 25 Spacer Rod | *45 Gasket (Side Cover) |
| *9 O-ring (2) | 26 Push Tube | 46 Side Cover Assembly |
| *10 Seal Ring | 27 Balls | 47 Jam Nut |
| *11 O-ring (Valve Housing) | 28 Ball Return Guide Halves (2) | 48 Special Bolts (6 or 8-Side Cover) |
| 12 Thrust Washer (Thick) | *29 Seal (Cap) | *49 Vent Plug (Side Cover) |
| 13 Input Shaft, Valve, Worm Assy. | 30 Ball Return Guide Cap | 50 Bleed Screw (Manual) |
| 13A Input Sh., Valve, Worm Assy. (Alt.) | *31 Torx Screws (2-Cap/Strap) | 51 Plug (Auto Bleed) |
| 14 Spacer Sleeve (Alt.) | *32 Ball Return Guide Strap | 52 Fixed Stop Screw (Poppet) |
| 15 Thrust Bearing (1 or 2) | 34 Housing | 52A Fixed Stop Screw (Poppet-Alt) |
| | 35 Grease Fitting | 53 Washer (Stop Screw) |
| | | 54 Auxiliary Port Plug (2) |
| | | *55 O-ring (2-Aux. Port Plug) |
| | | 56 Relief Valve Cap |
| | | *57 O-ring (Relief Valve) |
| | | 58 Relief Valve (2 piece) |
| | | 59 Service Poppet Adjusting Screw |
| | | 60 Service Sealing Jam Nut |

*These items are included in complete seal kits along with 406038 lubricant and a service bulletin.

Service Parts List - Standard

Common Parts

Item Description	Part Number
1 Bolts (4-Valve Housing)	020251
2 Dirt and Water Seal 13/16" Serr.	478044
2B Dirt and Water Seal 7/8" Serr.	478060
2C Dirt and Water Seal 1" Ser	478050
3 Retaining Ring	401637
4 Seal (Input Shaft) (High Temp)	478076
7 Seal Ring (Valve Housing)	032823
8 Seal Ring (2)	029123
9 O-ring (2) (High Temp)	032200-158
10 Seal Ring	029116
11 O-ring (Valve Housing) (High Temp)	032200-152
12 Thrust Washer (Thick)	400143
15 Thrust Bearing (2)	070027
16 Thrust Washer (Thin)	400144
17 Bearing Adjuster	400149
18 Adjuster Locknut	027007
27 Balls	213684-X1
29 Seal (Cap)	478042
30 Ball Return Guide Cap	400161
31 Torx Screws (2-Cap/Strap)	020228
32 Ball Return Guide Strap	400167
35 Grease Fitting	037032
43 Adjusting Screw (Sector Shaft)	021200
44 Retainer (Adjusting Screw)	062005
47 Jam Nut	025150
49 Vent Plug (Side Cover)	036201
50 Bleed Screw (Manual)	213705
51 Plug (Auto Bleed)	021397
52A Fixed stop screw	021426
54 Auxiliary Port Plug (2)	415437-A1
55 O-ring (2-Aux. Port Plug)	032229
57 O-ring (Relief Valve)	032200-153
59 Service Poppet Adjusting Screw	021407
60 Service Sealing Jam Nut	025119

Parts Vary by Specification*

Item Description
5 Valve Housing
13 Input Shaft, Valve, Worm Assy.
13A Input Shaft, Valve, Worm Assy. (Alt.)**
14 Spacer Sleeve (Alt.)**
19 Rack Piston
34 Housing
42 Sector Shaft
46 Side Cover Assembly
56 Relief Valve Cap
58 Relief Valve (2 piece)

*Contact Service/Sales for part numbers
 **Applicable to TAS65 gears only

Kits

Items	Description	Part Number
54 & 55	Port Plug & O-ring	415437-A1
56 & 57	Relief Valve Cap & O-ring	411061-A1
59 & 60	Adj. Screw & Jam Nut	021407-X1
2, 2B, 2C, 3, 4	Input Shaft Seal Kit	TAS000001
	TAS40 Seal Kit	TAS400003
	TAS55 Seal Kit	TAS550004
	TAS65 Seal Kit	TAS650012
	TAS85 Seal Kit	TAS850003 or 4

Parts Vary by Gear Size

Item Description	TAS40	TAS55	TAS65	TAS85
6 Seal Ring (Valve Housing)	032829	032829	032616	032834
20 Teflon Seal Ring	032828	032830	032590	032547
21 O-ring (Back up; Rack Piston)	032827	032831	032615	032556
22 Poppet Seat and Sleeve Assy. (2)	409118-A2	409118-A2	409118-A2	409118-A6
23 Poppet (2-old design)	040210	040210	040210	040217
23A Poppet (2-new design)	040248	040248	040248	040249
24 Poppet Spring	401662	401662	401662	401684
25 Spacer Rod	040209	040209	040209	040218
26 Push Tube	080154	080154	080154	080158
28 Ball Return Guide Halves (2) R.H.	400158	400160	400156	400162
L.H.	400159	400165	400157	400163
36 Retaining Ring (2)	401674	401650	401650	401685
37 Roller Bearing	070030	071032	071033	072004
38 Dirt Seal	478052	478041	478041	478057
39 Dirt and Water Seal (Trunnion)	478053	478045	478045	478059
40 Washer (Spacer)	028527	028519	028519	028534
41 Seal (2-Output)	478051	478040	478040	478084
45 Gasket (Side Cover)	HFB529000	HFB649000	HFB649000	TAS859000
48 Special Bolts (6 or 8-Side Cover)	021277	021434	021434	021434

**TRW**

TRW Automotive
Steering & Suspension Systems

Service Bulletin #TAS-101

On-Vehicle Poppet Readjustment for TAS Gears

Revised January, 1993
Electronic Version April, 1998

This TRW Commercial Steering Division service bulletin has been written to help you repair commercial vehicles more efficiently. This bulletin should not replace your manuals; you should use them together. These materials are intended for use by properly trained, professional mechanics, NOT "Do-it-yourselfers". You should not try to diagnose or repair steering problems unless you have been trained, and have the right equipment, tools and know-how to perform the work correctly and safely.

What are poppets?

Poppets are pressure unloading valves set to trip just before full turn is reached in each direction. When this procedure is completed correctly, system pressure will be reduced before the axle stop screw contacts the axle stop in both directions.

To determine if the poppets require readjustment or if they are performing properly, install a Power Steering System Analyzer (PSSA) between the power steering pump and the steering gear. If poppet readjustment is necessary, you can leave the PSSA in the system to verify that the following procedure is completed properly.

Why might poppets need to be readjusted?

- Changing to larger tires
- Reduced vehicle wheelcut
- Pitman arm mistimed, condition corrected
- Steering gear being installed on a different truck
- Steer axle stop bolt(s) were bent or broken
- Steer axle u-bolt(s) were bent or broken

NOTE

This resetting procedure will work in most cases with at least 1¼ hand-wheel-turns from each side of center. If you're making a large reduction in wheelcut and this procedure does not work, you may have to internally reset the poppets using the procedure described in the TAS Service Manual.

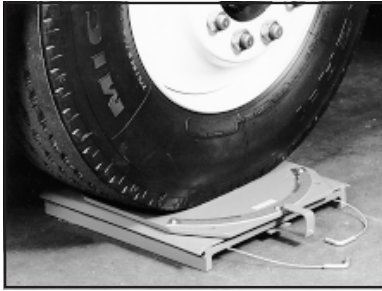

Set axle stops, warm-up system

1. Set the axle stops to vehicle manufacturer's wheelcut or clearance specifications.

Start the engine, and allow the vehicle to idle for 5-10 minutes to warm the hydraulic fluid. Shut off the engine.

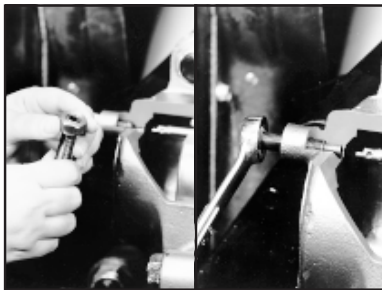

Assemble adjusting screw into nut

2. If a new poppet adjusting screw and nut are being used, turn the screw into the non-sealing end of the jam nut until the drive end of screw is flush with the nut.

Your steering gear will have either a fixed stop bolt or an adjusting screw. If the adjusting screw is already part of the steering gear, back the nut off of the adjusting screw until it is flush with the end of the adjusting screw.

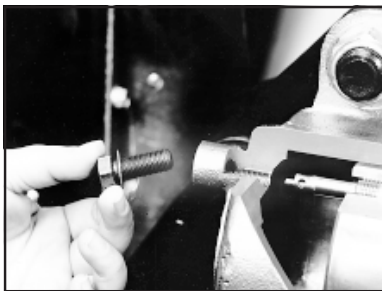

Remove poppet stop bolt

3. Make sure the engine is off and the road wheels are in straight ahead position. Remove and discard the poppet fixed stop bolt (if equipped) and washer (if equipped) from the lower end of housing.

If the unit has a poppet adjusting screw and sealing nut that need to be replaced, remove and discard them.

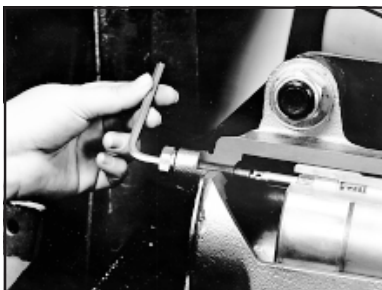

Turn adjusting screw assembly into housing

4. Turn the adjusting screw and sealing nut assembly, without rotating the nut on the screw, into the housing until the nut is firmly against the housing using a $\frac{7}{16}$ " allen wrench. Tighten the sealing nut against the housing.



Refill reservoir

5. Refill system reservoir with approved hydraulic fluid.

CAUTION Do not mix fluid types. Mixing of transmission fluid, motor oil, or other hydraulic fluids will cause seals to deteriorate faster.

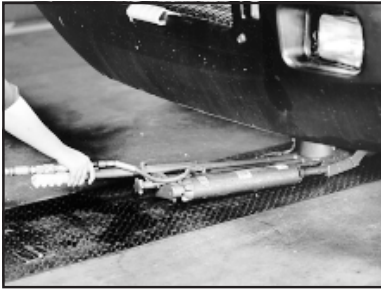

Jack up vehicle

6. Place a jack under the center of the front axle and jack up the front end of the vehicle so the steer axle tires are off the ground.

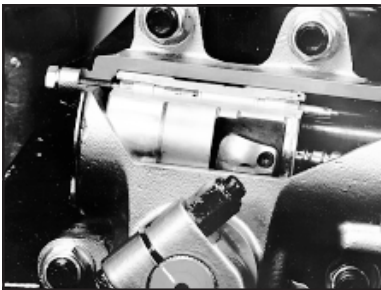

Push upper poppet out to prepare it for setting

7.
 - a) Start the engine and let it run at idle speed.
 - b) Note which output shaft timing mark is nearest the housing piston bore.
 - c) Turn the steering wheel in the direction that makes this timing mark move toward the adjusting screw just installed. Turn in this direction until axle stop contact is made.
 - d) Pull hard on the steering wheel (put 30 lbs. rim pull on a 20" dia. steering wheel) after the axle stop is contacted.

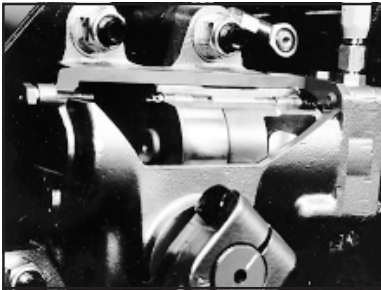

Set upper poppet

8.
 - a) Turn the steering wheel in the opposite direction (end of timing mark away from adjusting screw) until the other axle stop is contacted.
 - b) Pull hard on the steering wheel (put 30 lbs. rim pull on a 20" dia. steering wheel).
 - c) Release the steering wheel and shut off the engine.

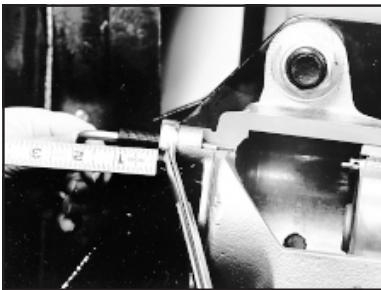

Back out adjusting screw

9. Loosen the sealing nut and back out the adjusting screw until 1" is past the nut. Tighten the sealing nut against the housing.



Set lower poppet

10.
 - a) Start the engine and let it idle.
 - b) Turn the steering wheel in the original direction (end of timing mark toward adjusting screw), until axle stop contact is made.
 - c) Hold the steering wheel in this position (with 30 lbs. rim pull) for 10 seconds, then release. Repeat this hold and release process as many times as necessary while completing step 11.

CAUTION Do not hold the steering wheel at full turn for more than 10 seconds at a time; the heat build-up at pump relief pressure may damage components.

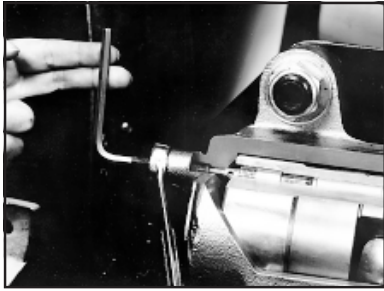

Position adjusting screw

The procedure is complete

11.
 - a) With steering wheel held at full turn, loosen the jam nut and hold it in place with a wrench.
 - b) Turn the adjusting screw in (clockwise) using finger- pressure only (don't use a ratchet), until the Allen wrench comes to a stop. Do not attempt to turn it in farther. Pause the turning-in process each time the driver releases the steering wheel; Continue turning only while the wheel is held at full turn.
 - c) Back off the adjusting screw 3/4 turns and tighten the sealing nut. Torque the sealing nut to **33-37 lbf-ft.**
12. The poppets have now been completely reset. Lower the vehicle . Check the reservoir and fill if required.

WARNING The length of the adjusting screw beyond the nut must be **no more than 1 1/16"** for proper thread engagement.

NOTE The length of adjusting screw beyond the sealing nut may be different for each vehicle.



TRW Automotive
Commercial Steering Systems

Steering Diagnostics Service Manual

CHART YOUR WAY TO EASY STEERING





⚠ WARNING A warning describes hazards or unsafe practices which could result in severe personal injury or death.

⚠ CAUTION A caution describes hazards or unsafe practices which could result in personal injury or product or property damage.

NOTE A note gives key information to make following a procedure easier or quicker.

Notice

This guide was prepared for the purpose of providing general advice concerning the diagnosis and correction of commercial vehicle steering related problems. This guide is intended for the use of properly trained, professional mechanics, NOT "Do-it-Yourselfers". Also, this guide should be used in conjunction with service manuals provided by both the vehicle and component manufacturers. Diagnosis and correction of commercial vehicle steering related problems should only be handled by properly trained, professional mechanics who have the proper equipment, tools, instructions and know-how to perform the work properly and safely.

Power Steering System Analyzer (PSSA) Gauge

Some of the tests in this manual require the use of a PSSA. This device is a combination flow meter, shut-off valve, and pressure gauge. This tool will allow you to measure flow and pressure, and provide a load on the pump through the hydraulic lines of the steering system. This tool is required to correctly analyze a steering system. TRW recommends that you **DO NOT BEGIN TROUBLESHOOTING A STEERING SYSTEM WITHOUT THE USE OF A PSSA**. If you are not sure how to use a PSSA, you may refer to the video available through our website at: www.trucksteering.com. This video compliments the tests in this book which require the use of the PSSA.

⚠ WARNING

Throughout this troubleshooting guide, test procedures are recommended to help locate the cause of each complaint. While performing these tests, TRW advises that you **TAKE NECESSARY PRECAUTIONS** when working with internal vehicle components and hot hydraulic fluids.

This page intentionally left blank



Table of Contents

Preface	3
Flow Chart Diagrams	7
Test Procedures	19
Comments	35
Test Results	39

This page intentionally left blank



Section 1 Preface

Introduction 3
 Understanding the Complaint
 Reading the Flow Charts
 Warranty

Definitions 4-5
 Hard Steering
 Reduced Wheelcut
 Steering Wheel Kick
 Binding, Darting, and Oversteer
 Directional Pull
 Road Wander/Loose Steering
 Non-Recovery
 Shimmy
 Noise
 External Leakage



This page intentionally left blank



Introduction

Understanding the Complaint

Steering systems for heavy duty trucks are made up of many components from the steering wheel to the road wheel. The purpose of the steering system is to give the driver directional control of the vehicle.

When a driver feels the steering control over his/her vehicle is not like it should be, it is up to you to determine if there is a problem, and if so, figure out what is causing it. It is always easier to fix something if you really understand the complaint. Some ways you could do this are:

- Talk to the driver and ask a lot of questions like "what, when, where, and how"
- Make sure you can feel or see the problem. Have the driver show you exactly what he/she means.
- Walk around the truck, looking for anything that may be an obvious cause of the problem.

To make your job easier and faster this manual has both the flow charts and test procedures/comments, each in their own section. Once you have a good understanding of what the complaint is, choose the flow chart that best matches the symptoms described to you. Because there are different ways to say the same thing, we have provided our definitions of the 10 most common complaints in this book. Use these to determine which section of the manual would be helpful to begin diagnosing the steering system.

Reading the flow charts:

Start the chart at the **BEGIN** box. Follow the lines to the next box answer the question or perform the test to verify the cause of the complaint, then proceed to the next step. These boxes are arranged in order of likelihood of being the cause of the driver's complaint. **It is important to complete the tests, in order, and follow the flow of the chart.** Locate correct test number in the TEST PROCEDURES section, and follow the test procedure. When you are done with the test, note the results and correct the root cause. If condition still exists, keep going through the chart (if necessary, to correct the problem). The results of some tests will need to be recorded. Use the TEST RESULTS section to record these values.

If you identify a problem through a test procedure it is important that you retest the vehicle to make sure the condition has been corrected.

Warranty

If you have identified that a steering component on your vehicle needs to be replaced, this does not always mean it is warrantable. Please read your manufacturer's warranty carefully before submitting a steering component for warranty consideration.

Definitions

1. Hard Steering

Hard Steering is when steering effort at the steering wheel is more than 200 inch pounds (typically 18-22 lbs at the rim of the steering wheel). Steering is still possible, but there is not enough power assist.

Common phrases used:

- Won't turn
- Locks-up
- Shuts-down
- Turns hard
- Hangs-up
- No assist
- Won't turn unless moving

2. Reduced Wheelcut

Common phrases used:

- Too great of turning radius required
- Wheelcut restricted
- Not enough turns lock to lock

3. Steering Wheel Kick

Steering Wheel Kick is when the road wheels hit a bump that the steering wheel reacts to. The kick is usually dampened out quickly.

Common phrases used:

- Kickback
- Backlash
- Bump steer

4. Binding, Darting and Oversteer

Binding is a change or increase in steering wheel effort. Binding will usually not require the effort levels described in Hard Steering, unless it is severe. Darting and oversteer are words that mean the driver suddenly gets more turning than he/she wants.

5. Directional Pull

Common phrases used:

- Steering pulls to the right (or left)
- Truck pulls to the right (or left)
- A constant force is required to keep the truck going straight



Definitions

6. Road Wander/Loose Steering

Common phrases used:

- Lash in steering
- Lost motion in steering
- Continual corrections are needed at the steering wheel to keep the vehicle from wandering

7. Non-Recovery

Common phrases used:

- Wheels don't return to straight ahead

8. Shimmy

A severe Shimmy condition can be felt at the steering wheel. Typically once something triggers a Shimmy condition to occur it is sustained until the driver does something (such as slow down) to dampen out the condition.

Common phrases used:

- Shake at steering wheel

9. Noise

Common phrases used:

- Steering is noisy
- Clicking or clunking sound is heard when steering

10. External Leakage

Common phrases used:

- Loss of steering fluid
- Continual adding of fluid in reservoir required

This page intentionally left blank



Section 2 Flow Chart Diagrams

Hard Steering	8
Reduced Wheelcut	9
Steering Wheel Kick	10
Binding, Darting, and Oversteer	11
Directional Pull	12
Road Wander/Loose Steering	13
Non-Recovery	14
Shimmy	15
Noise	16
External Leakage	17

Hard Steering

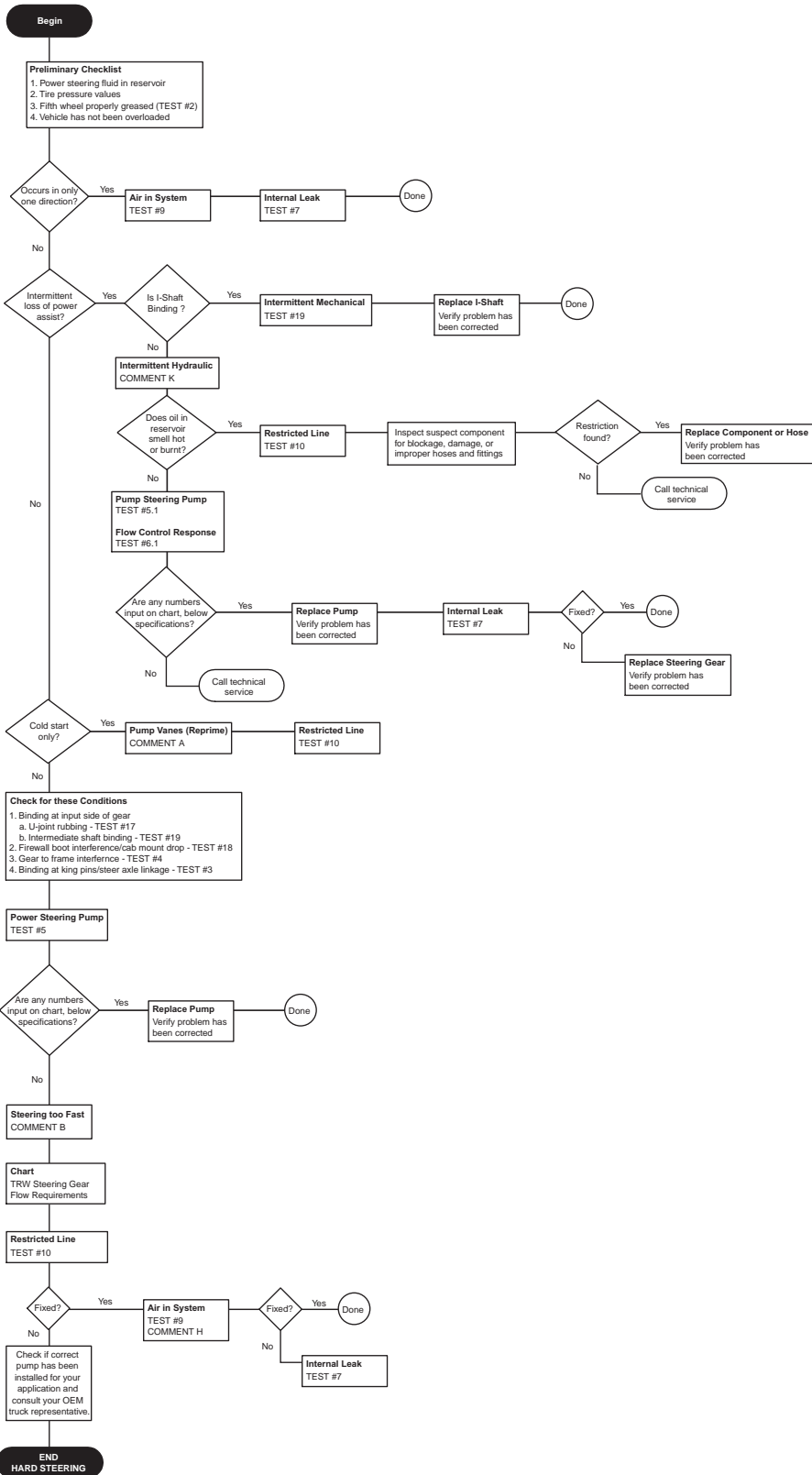

870



Reduced Wheelcut

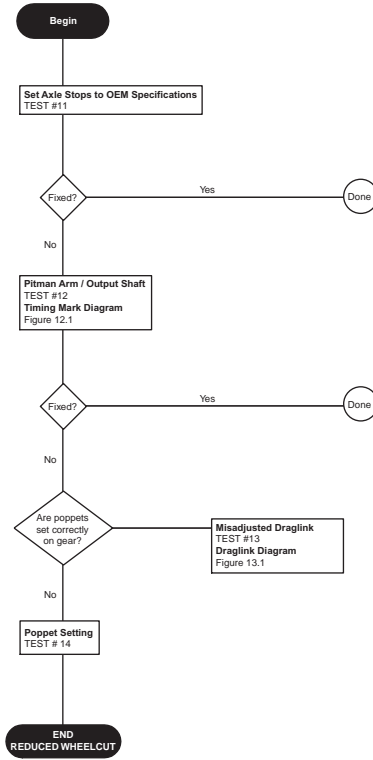

Steering Wheel Kick

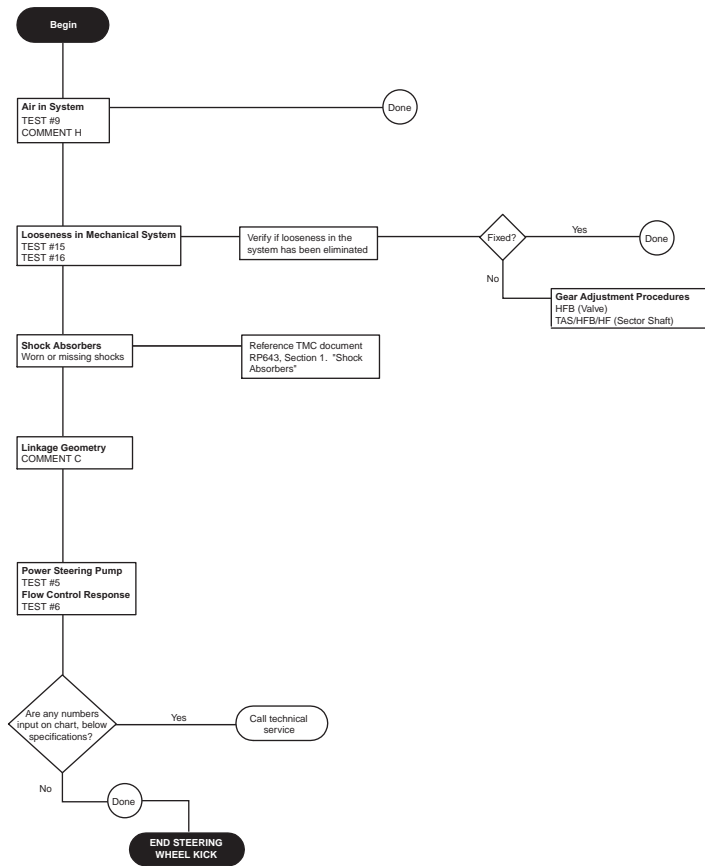



Binding, Darting, and Oversteer

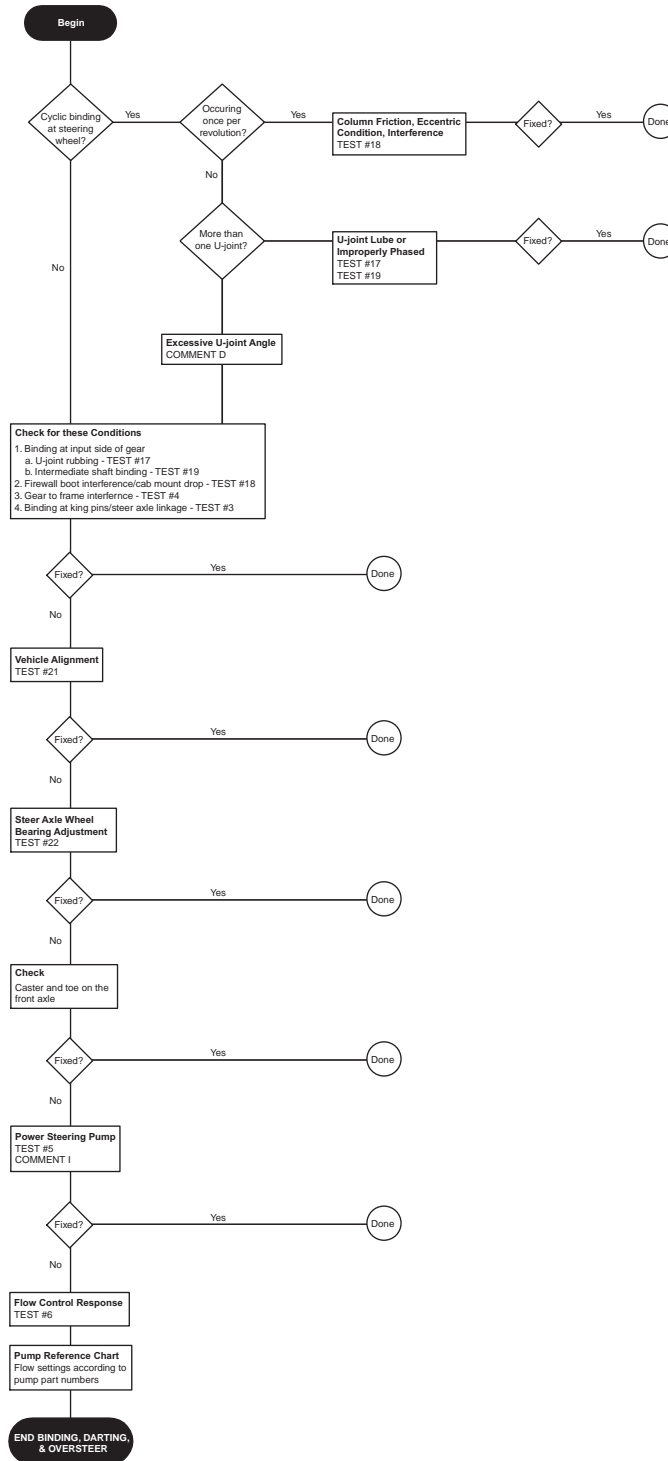

Directional Pull

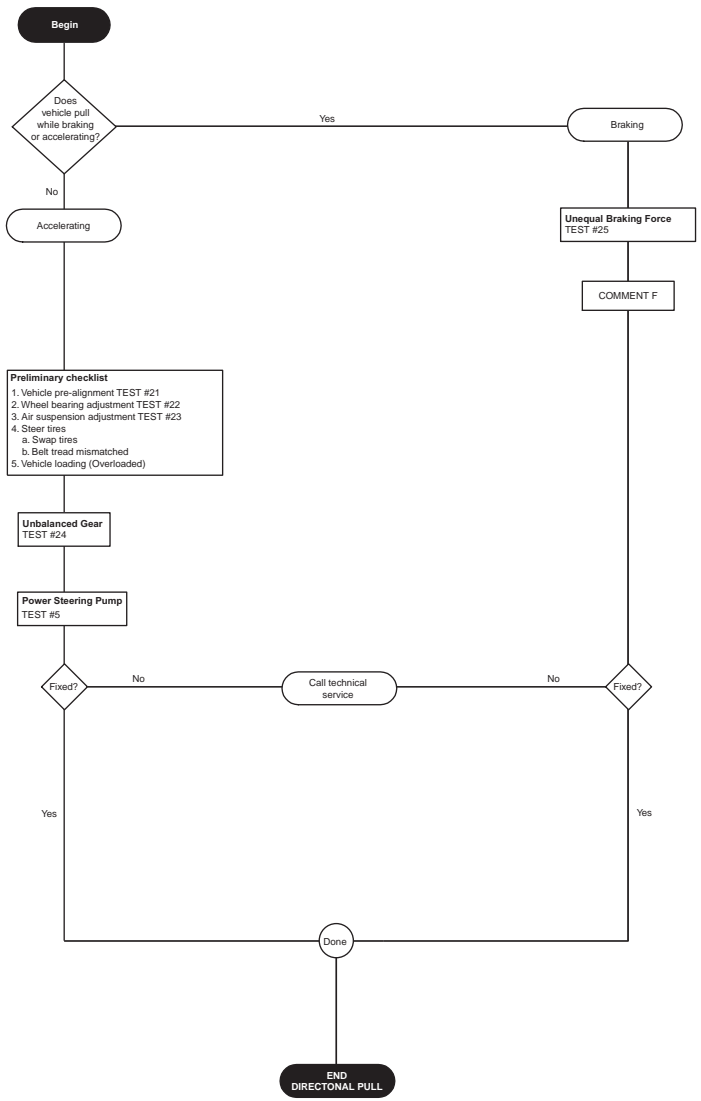



Road Wander/Loose Steering

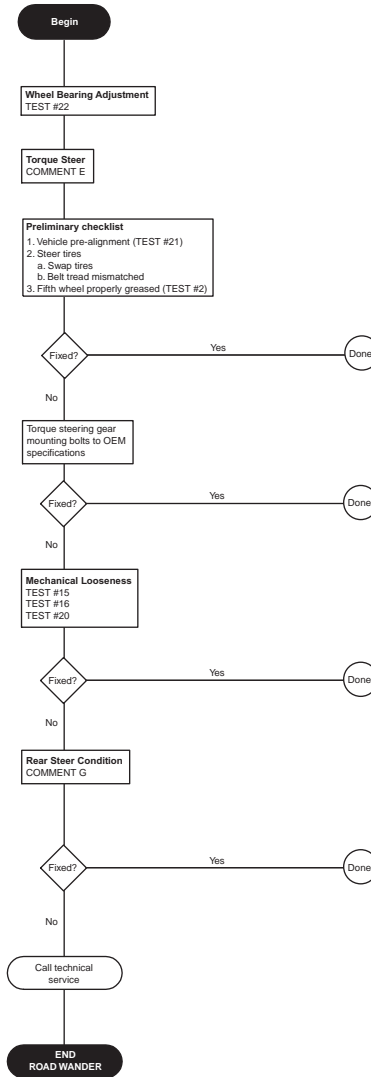

Non-Recovery

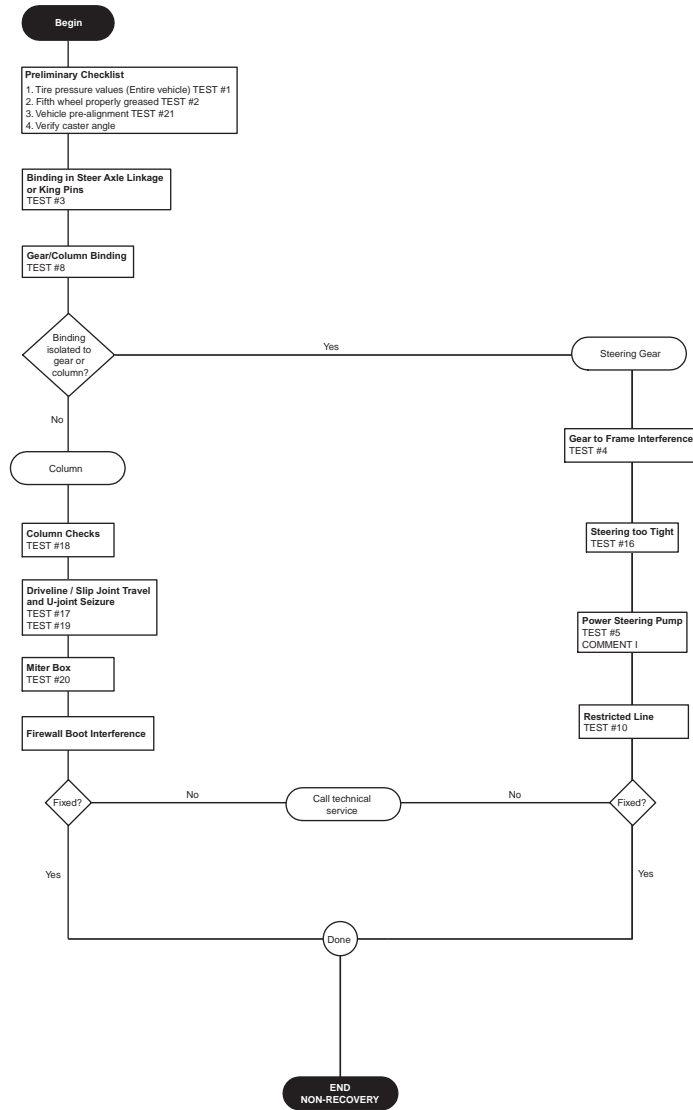



Shimmy

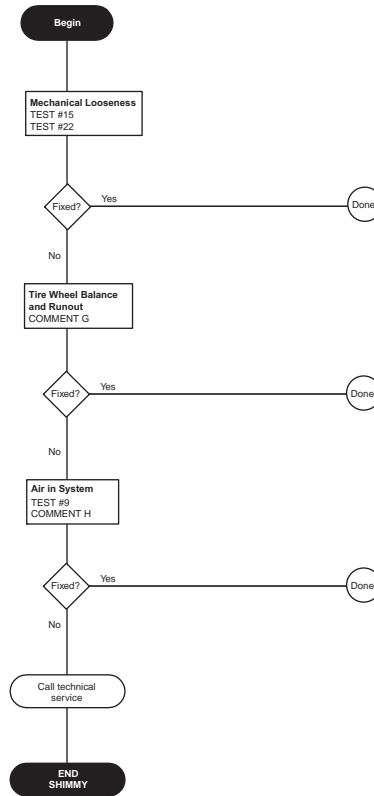

Noise

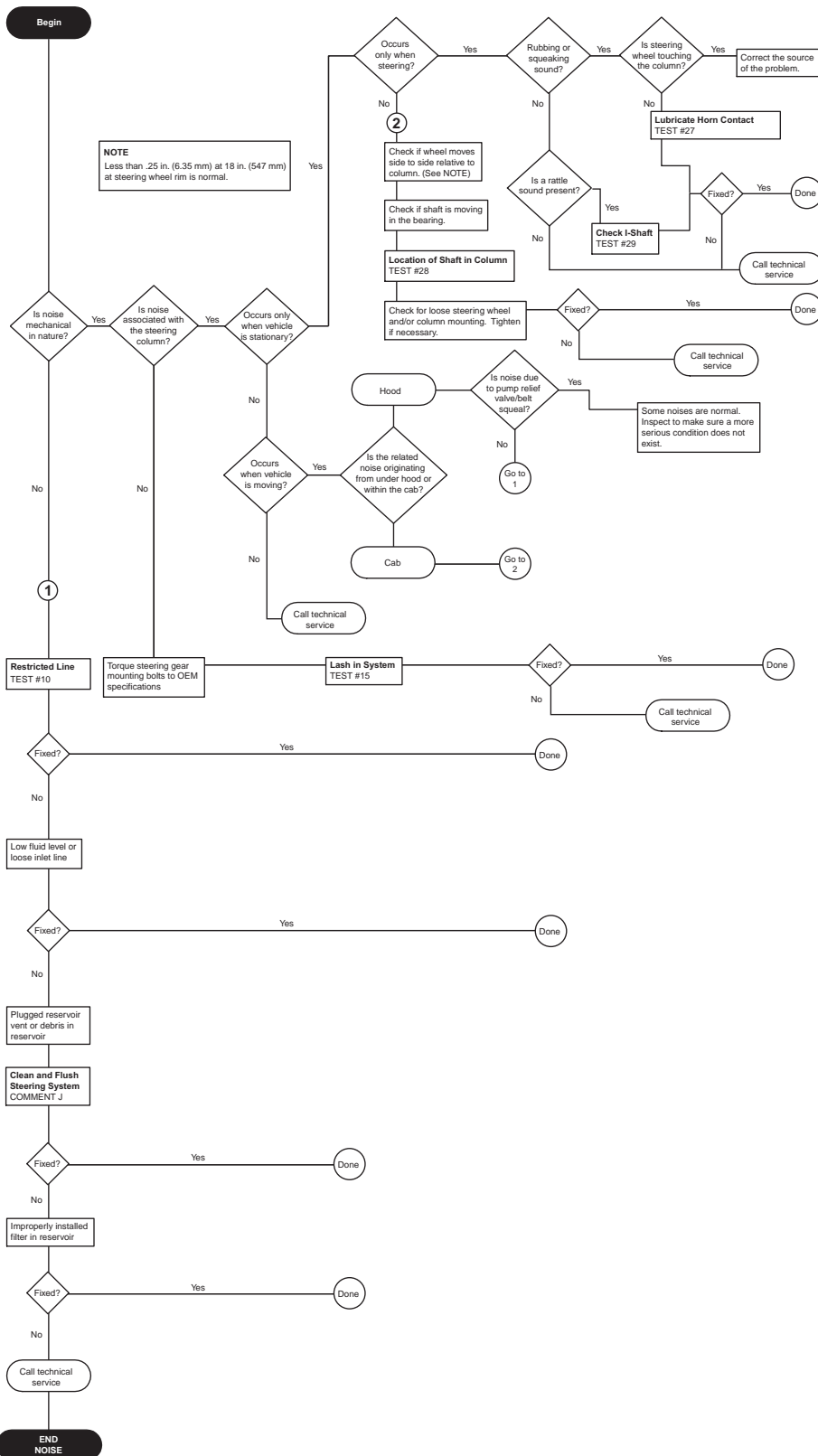



External Leakage

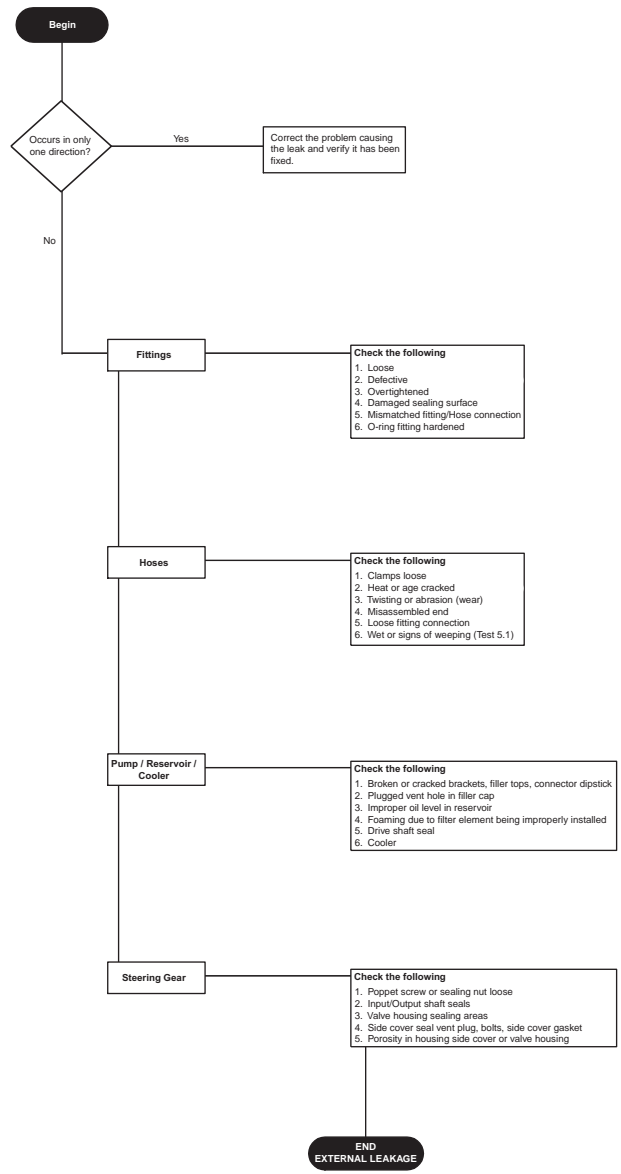

This page intentionally left blank



Section 3 Test Procedures

Test #1 - #3 20
Test #4 21
Test #5 22
Test #5.1 23
Test #6 24
Test #6.1 25
Test #7 26
Test #8 - #9 27
Test #10 28
Test #11 - #14 29
Test #15 - #16 30
Test #17 - #19 31
Test #20 - #25 32
Test #26 - #29 33

Test #1

Steer Tire Check

1. Look for: Tire damage, Uneven or extreme tread wear, mismatched tires or other wear indicators that would cause the problem. *Figure 1.1.*
2. Check tire pressures on steer axle tires. *Figure 1.2.*

Test #2

Fifth Wheel and Trailer Plate

1. Look for dry fifth-wheel or trailer plate. *Figure 2.1.*
2. Look for damage to fifth-wheel or trailer plate. *Figure 2.2.*
3. Inspect fifth-wheel for looseness.

Test #3

Steer Axle and Linkage Binding

1. With vehicle steer tires on radius plates (turntables) or equivalent, disconnect the drag link or pitman arm from the steering gear, (and linkage from assist cylinder if there is one on the vehicle). *Figure 3.1.*

⚠ CAUTION Do not steer the gear with linkage removed, as misadjustment of automatic poppets may result.

2. By hand, pull the tire to one axle stop and release (engine off). The tire should self-return to near straight ahead. *Figure 3.2.*
3. Repeat the test in the opposite direction.
4. If tire does not self-return to near straight ahead, a problem is likely in steer axle king pin bushings/bearings or linkage.

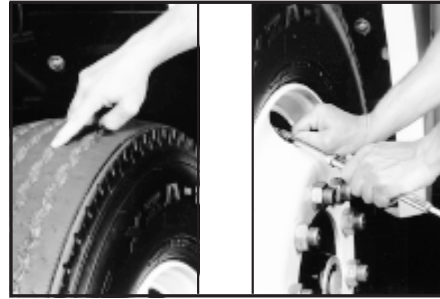

Figure 1.1

Figure 1.2

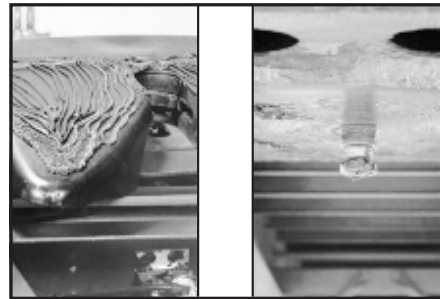

Figure 2.1

Figure 2.2



Figure 3.1



Figure 3.2

**Test #4****Steering Gear Mounting**

1. Look for anything between the steering gear and frame that could cause a binding problem. For example: hoses or brackets that have been routed, or are interfering between the steering gear and frame, frame flanges or spring mounting points. *Figure 4.1.* Mounting pads lower than steering gear housing, lack of clearance between frame and steering gear valve housing adapter, sector shaft adjusting screw and nut contact with access adjustment hole in frame. If interference is found, correct the problem.
2. If the steering gear has been mounted to the frame in a way that causes the gear to distort (not be flat), it may cause a steering problem. *Figure 4.2.* Checking to see if distortion is present on the vehicle may require the following test:
3. With vehicle parked and engine running, steer the wheel slowly checking for a binding-type of feel at the steering wheel. When binding is felt (stop engine loosen one mounting bolt restart engine) and steer the vehicle again. Continue to loosen one mounting bolt at a time, shutting off engine each time, and check for improvement in the binding condition. If improvement is made by loosening the bolts, determine by inspection the condition causing the gear to distort and correct the problem. Distortion of .030" (.80 mm) or less is acceptable. If greater than .030" (.80 mm) surface flatness, condition must be corrected.

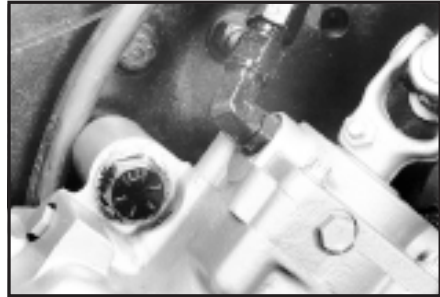

Figure 4.1

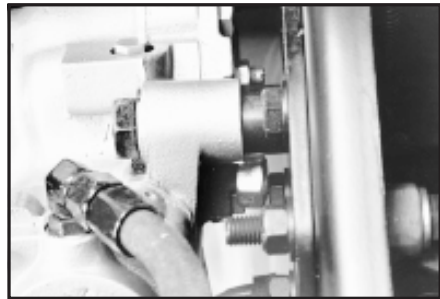

Figure 4.2

**Test #5
Power Steering Pump Test**

IMPORTANT: Read the following instructions below before completing **Table 5**, located in the "TEST RESULTS" section.

Verify Engine Idle speed per your OEM specifications.

1. Install temperature gauge in reservoir. *Figure 5.1.* Install PSSA in pressure line with shut-off valve fully open. *Figure 5.2.*
2. Run the engine at 1000 rpm.

CAUTION When closing the PSSA shut off valve, do so slowly and keep an eye on the pressure gauge. Do not allow the system to exceed 3000 psi (207 bar) for safety of personnel and to prevent damage to the vehicle.

CAUTION Do not keep the load valve closed for more than 5 seconds at a time because damage to the system may result from excessive heat build-up.

3. Measure and record the following flow and pressure readings (see chart) by adjusting the load valve while listening for any unusual noises as the valve is being opened and closed. *Figures 5.3-5.7.*
4. Now with the load valve fully open, increase the engine speed to governed RPM and measure and record the following flow and pressure readings by adjusting the load valve while listening for any unusual noises as the valve is being opened and closed.
5. Determine the recommended flow range and maximum allowable system pressure for the steering system being used by referring to your service manual.
6. Compare the minimum and maximum flows (and the relief pressure you measured) to gear and pump specifications.
7. If the minimum measured pump flow is less than the minimum recommended flow for the steering gear used (see **Steering Gear Flow Requirements** chart), the pump may not be putting out enough flow for an adequate steering speed. If the maximum system pressure is lower than that specified for the pump (check your manual), it may not be developing enough pressure to steer. If either case exists, the pump needs to be repaired or replaced.

NOTE When hydraulic tests are completed and fluid lines are reconnected, check fluid level and bleed the air from the hydraulic system.

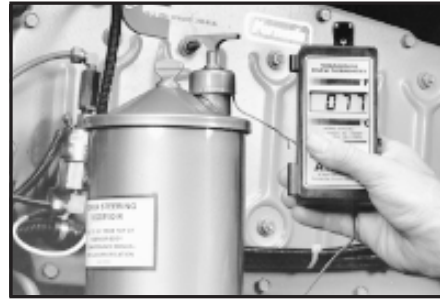

Figure 5.1

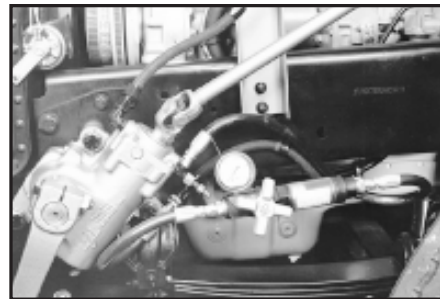

Figure 5.2

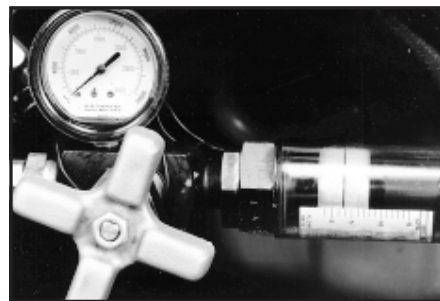

Figure 5.3

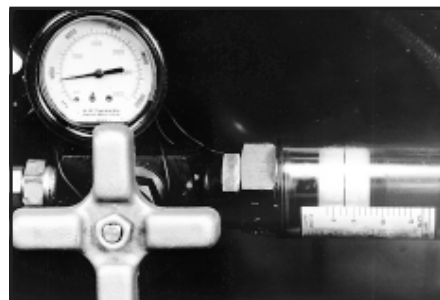

Figure 5.4

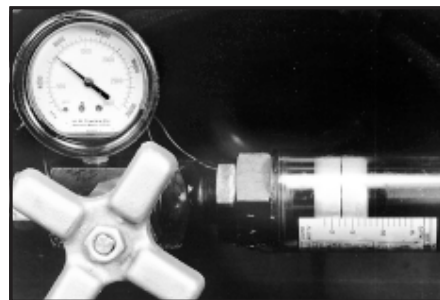

Figure 5.5



Test #5.1

40 Minute Power Steering Pump Test

IMPORTANT: Read the following instructions below before completing **Table 5.1** in the "Test Results" section.

Verify Engine Idle speed per your OEM specifications

1. Install temperature gauge in reservoir. *Figure 5.1*. Install PSSA in pressure line with shut-off valve fully open. *Figure 5.2*. Park the vehicle outside. Record ambient temperature. Run the engine at governed RPM for 40 minutes to bring the fluid up to an elevated testing temperature. Measure and record the fluid temperature at the start and at 10, 20, 30 and 40 minutes. Do not allow the temperature to exceed 250° F (121° C).

NOTE

If the temperature goes over 250° F (121° C) , or 150° F (66° C) above the surrounding temperature (ambient) at any time during the test, stop the test. This temperature level is considered extreme and steering system performance and life will be seriously affected. Damage to hoses, seals, and other components may result if operated at extreme temperature. If the steering system is operating above the recommended temperatures, the heat problem may be the root cause of the complaint.

2. Run the engine at idle speed.

CAUTION When closing the PSSA shut off valve, do so slowly and keep an eye on the pressure gage. Do not allow the system to exceed 3000 psi (207 BAR) for safety of personnel and to prevent damage to the vehicle.

CAUTION Do not keep the load valve closed for more than 5 seconds at a time because damage to the system may result from excessive heat build-up.

3. Measure and record the following flow and pressure readings (see chart) by adjusting the load valve while listening for any unusual noises as the valve is being opened and closed. *Figures 5.3-5.7*.
4. Now with the load valve fully open, increase the engine speed to governed RPM and measure and record the following flow and pressure readings by adjusting the load valve while listening for any unusual noises as the valve is being opened and closed.
5. Determine the recommended flow range and maximum allowable system pressure for the steering system being used by referring to your service manual.
6. Compare the minimum and maximum flows, and the relief pressure you measured to gear and pump specifications.
7. If the minimum measured pump flow is less than the minimum recommended flow for the steering gear used (see **Steering Gear Flow Requirements** chart), the pump may not be putting out enough flow for an adequate steering speed. If the maximum

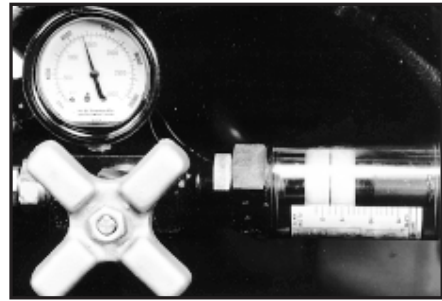

Figure 5.6

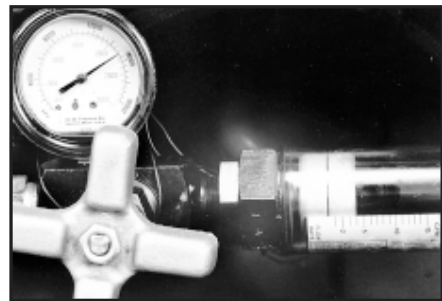

Figure 5.7

system pressure is lower than that specified for the pump (refer to your OEM service manual), it may not be developing enough pressure to steer. If either case exists, the pump needs to be repaired or replaced.

NOTE When hydraulic tests are completed and fluid lines are reconnected, check fluid level and bleed the air from the hydraulic system.

**Test #6
Pump Flow Control Response**

IMPORTANT: Read the following instructions below before completing **Table 6**, in the "Test Results" section

1. Install temperature gauge in reservoir. *Figure 6.1*. Install PSSA in pressure line with shut-off valve fully open. *Figure 6.2*.

NOTE If the temperature goes over 250° F (121° C) , or 150° F (66° C) above the surrounding temperature (ambient) at any time during the test, stop the test. This temperature level is considered extreme and steering system performance and life will be seriously affected. Damage to hoses, seals, and other components may result if operated at extreme temperature. If the steering system is operating above the recommended temperatures, the heat problem may be the root cause of the complaint.

CAUTION Do not keep the load valve closed for more than 5 seconds at a time because damage to the system may result from excessive heat build-up. (Do not allow the pressure to exceed 3000 psi (207 bar).

2. With the engine at idle, note the flow rate. Fully close the load valve until the flow drops to zero. Quickly open the load valve observing the flow meter. The flow rate must instantly return to the reading you noted above.
3. With the load valve open run the engine to governed speed and note the flow rate. Fully close the load valve until the flow drops to zero. Quickly open the load valve observing the flow meter. The flow rate must instantly return to the reading noted above.
4. Conduct this pump response test three times at idle and three times at 1500 RPM. If the flow rate does not return immediately, the pump is malfunctioning, which can result in momentary loss of power assist.

NOTE When hydraulic tests are completed and fluid lines are reconnected, check fluid level and bleed the air from the hydraulic system.

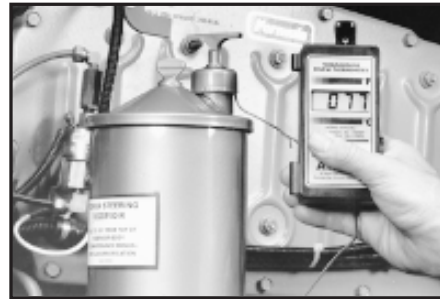

Figure 6.1

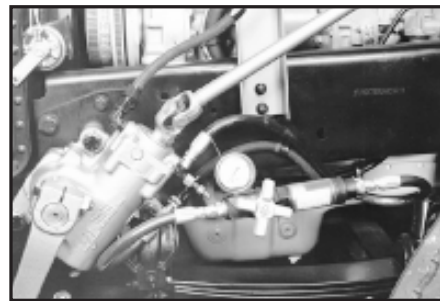

Figure 6.2

**Test #6.1****40 Minute Pump Flow Control Response**

Read the following instructions below before completing **Table 6.1** in the "Test Results" section

1. Install temperature gauge in reservoir. *Figure 6.1*. Install PSSA in pressure line with shut-off valve fully open. *Figure 6.2*. Park the vehicle outside. Record ambient temperature. Run the engine at governed RPM for 40 minutes to bring the fluid up to an elevated testing temperature. Measure and record the fluid temperature at the start and at 10, 20, 30, and 40 minutes. Do not allow the temperature to exceed 250° (121°C)

NOTE

If the temperature goes over 250° F (121° C) , or 150° F (66° C) above the surrounding temperature (ambient) at any time during the test, stop the test. This temperature level is considered extreme and steering system performance and life will be seriously affected. Damage to hoses, seals, and other components may result if operated at extreme temperature. If the steering system is operating above the recommended temperatures, the heat problem may be the root cause of the complaint.

CAUTION

Do not keep the load valve closed for more than 5 seconds at a time because damage to the system may result from excessive heat build-up. (Do not allow the pressure to exceed 3000 psi (207 bar).

2. With the engine at idle, note the flow rate. Fully close the load valve until the flow drops to zero. Quickly open the load valve observing the flow meter. The flow rate must instantly return to the reading you noted above.
3. With the load valve open run the engine to governed speed and note the flow rate. Fully close the load valve until the flow drops to zero. Quickly open the load valve observing the flow meter. The flow rate must instantly return to the reading noted above.
4. Conduct this pump response test three times at idle and three times at 1500 RPM. If the flow rate does not return immediately, the pump is malfunctioning, which can result in momentary loss of power assist

NOTE

When hydraulic tests are completed and fluid lines are reconnected, check fluid level and bleed the air from the hydraulic system.

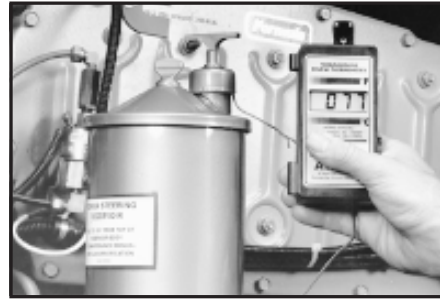

Figure 6.1

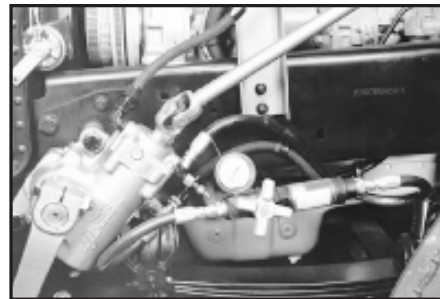

Figure 6.2

Test #7

Measured Internal Leakage

1. Install temperature gauge in reservoir. *Figure 7.1.* Install PSSA in pressure line with shut-off valve fully open. *Figure 7.2.*

⚠ WARNING THIS TEST CAN BE DANGEROUS IF NOT PERFORMED CORRECTLY. KEEP YOUR FINGERS CLEAR OF THE AXLE STOPS AND SPACER BLOCK DURING THIS TEST. MAKE SURE THAT THE SPACER BLOCK CONTACTS THE AXLE STOP SQUARELY. CONTACT THAT IS NOT SQUARE COULD BREAK THE AXLE STOPS OR DANGEROUSLY THROW OR EJECT THE SPACER BLOCK.

2. To test the steering gear for internal leakage, you must first prevent operation of the gear's internal unloading (poppet) valves or relief valve (or both, in some gears). This will allow full pump relief pressure to develop. To prevent operation of the poppets, place an unhardened steel spacer block, about one inch thick and long enough to keep your fingers clear between the axle stop at one wheel. *Figures 7.3-7.4.* To prevent operation of the relief valve, remove the relief valve cap, o-ring and two piece relief valve, if equipped, from valve housing. Install the relief valve plug, special tool number J37130 in its place.

NOTE Be sure you reinstall the relief valve and valve cap with new o-ring, back onto the gear after leakage test.

⚠ CAUTION When running this test, do not hold the steering wheel in the full turn position for longer than 5 to 10 seconds at a time to avoid damaging the pump.

⚠ WARNING KEEP YOUR FINGERS CLEAR OF THE AXLE STOPS AND SPACER BLOCK DURING THIS TEST. MAKE SURE THAT THE SPACER BLOCK CONTACTS THE AXLE STOP SQUARELY. CONTACT THAT IS NOT SQUARE COULD BREAK THE AXLE STOPS OR DANGEROUSLY THROW OR EJECT THE SPACER BLOCK.

3. With the fluid temperature between 125-135° F (52-57° C), turn the steering wheel until the axle stop bolt contacts the spacer block.
4. Apply 20 pounds of force to the rim of the steering wheel during this test to be sure that the steering gear control valve is fully closed. *Figure 7.5.* The pressure gauge should now read pump relief pressure, as noted during the Flow Control Response Test (Test #6). You can now read steering gear internal leakage on the flow meter.
5. Repeat this test for the opposite direction of turn.
6. If internal leakage is greater than 1 gpm (3.8 lpm) and there is no auxiliary hydraulic linear or rotary cylinder in the system, repair or replace the gear. If the internal leakage is greater than 2 gpm (7.6 lpm), and there is an auxiliary hydraulic linear or rotary cylinder in the system, controlled by the gear, isolate the auxiliary cylinder from the system by disconnecting the auxiliary cylinder hydraulic

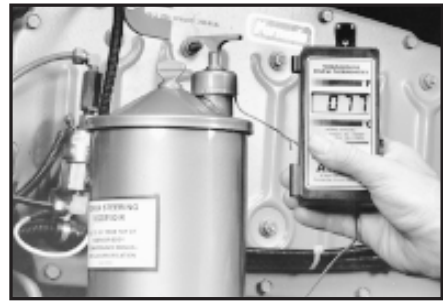

Figure 7.1

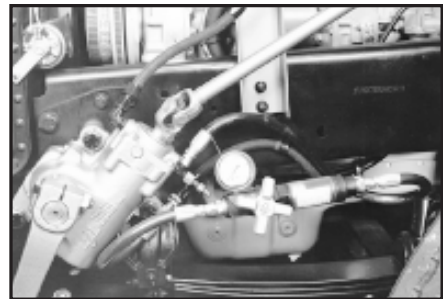

Figure 7.2



Figure 7.3



Figure 7.4



Figure 7.5



lines at the gear auxiliary ports. Plug the steering gear ports with suitable steel or high pressure plugs or caps.

In the event that a rotary cylinder is used in the system, connect the disconnected lines together with a suitable union fitting. In the case of a linear cylinder, first plug the disconnected lines and then disconnect the cylinder from the steering linkage, making sure it will clear the steered axle. *Figures 7.6-7.7.*

Repeat the internal leakage test. If the internal leakage is less than 1 gpm (3.8 lpm), repair or replace the auxiliary cylinder. If the internal leakage is greater than 1 gpm (3.8 lpm), repair or replace the gear.

NOTE When hydraulic tests are completed and fluid lines are reconnected, check fluid level and bleed the air from the hydraulic system.

Test #8 Steering Column Binding

1. With the vehicle parked, the engine off, and the steer axle jacked-up, slowly steer the vehicle until the binding position is located.
2. With the steering gear at this position, remove the steering column assembly from the steering gear. Note the correct position of the column and steering gear for reassembly after test. *Figure 8.1*
3. Rotate the steering gear input shaft no more than 1/4 turn each direction and check if binding is still present. *Figure 8.2* If binding is not felt, correct the steering column problem.

Test #9 Air in Hydraulic System

1. Inspect reservoir for foaming or air bubbles. *Figure 9.1* If foaming or bubbles are seen, air is being sucked into the system through cracks or loose fittings. Look for oil level changes engine off versus engine on, if fluid level increases when the vehicle is shut off, there is an air pocket trapped in the steering gear. The increase may not be noticeable, depending on the size of the pocket.
2. Bleed the steering gear (if there is a manual bleed screw at the top of the gear). With system at normal operating temperature and engine at proper idle speed and running, open the bleed screw and wait until clean, clear oil begins to flow from the gear. Close the bleed screw and steer the vehicle completely from stop to stop.
3. Repeat the bleeding operation three times, and recheck oil level in reservoir to make sure there is enough oil for the system to operate properly.



Figure 7.6

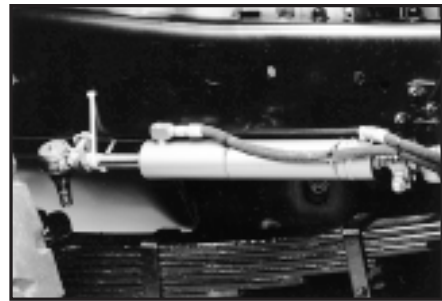

Figure 7.7



Figure 8.1



Figure 8.2



Figure 9.1

27

Test #10
Restricted Hydraulic Line

Read the following instructions below before completing **Table 10**, in the "Test Results" section

1. Look at the supply line that goes to the pump to check for kinking or any other obstructions or irregularities on the inside of the hose. *Figure 10.1.*
2. Install PSSA with load valve fully open. *Figures 10.2-10.3.* Insert temperature gauge into reservoir. With oil between 125-135 °F (52-57 °C), determine a test engine speed (RPM) that causes pump to deliver 3, 4, 5 or 6 gpm (11, 15, 19, or 23 lpm) (whichever is easier) and note this speed.
3. Remove the PSSA and install a low pressure gauge (200-300 psi (14-21 bar)) maximum with approximately 10 psi (.70 bar) per division) in the pressure line to the steering gear at the pump end. Install a temperature gauge in the power steering reservoir.

CAUTION Do not allow system pressure to exceed the rating of the gauge during the following procedure or damage to the gauge will result. Extremely high restrictions may be indicated with the PSSA gauge as installed with load valve fully open.

NOTE Be sure that the steering gear input shaft is not being restrained from recentering because this will cause a false steering gear pressure drop. If there is any question, conduct this test with the steering column removed.

4. Bring the power steering fluid temperature to 125-135 °F (52-57 °C), at engine idle, with no steering force applied to the steering wheel. *Figure 10.4.*
5. At the test engine speed selected from step 2 above, measure and record the gauge reading and shut off the engine. This measures total system pressure.
6. Remove the pressure and return lines from the steering gear and connect them together with a fitting that will not restrict the flow. *Figure 10.5.*
7. Start the engine, and run at the RPM identified in step 2 with the fluid temperature between 125-135 °F (52-57 °C).
8. Measure and record gauge reading and shut off engine. This is hydraulic line/reservoir pressure.
9. The difference between the total system pressure gauge reading and the hydraulic line/reservoir pressure gauge reading is the steering gear pressure drop. For a TRW steering gear, at a flow of 3, 4, 5 or 6 gpm (11, 15, 19, or 23 lpm), the drop should not be greater than 30, 40, 55 or 70 psi (2.0, 2.8, 3.8, 4.8 bar) respectively. The line/reservoir pressure drop for a flow of 3, 4, 5 or 6 gpm (11, 15, 19, or 23 lpm) should not be greater than 20, 20, 25 or 25 psi (1.4, 1.4, 1.7, 1.7 bar) respectively.



Figure 10.1

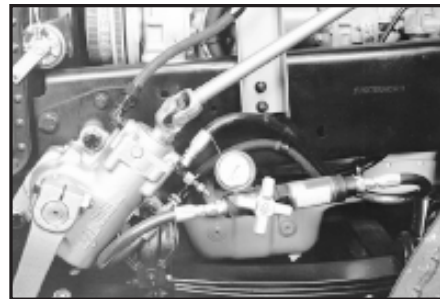

Figure 10.2

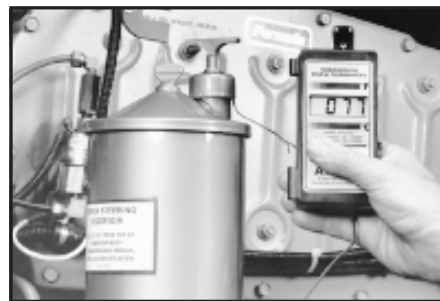

Figure 10.3



Figure 10.4



Figure 10.5



Test #11
Axle Stop Setting

Put vehicle steer tires on radius plates (turntables). Check to make sure axle stops are set to manufacturer's specifications. *Figure 11.1.*



Figure 11.1

Test #12
Pitman Arm and Output Shaft Alignment

Look to make sure the output shaft timing mark is lined up with the pitman arm timing mark. Some pitman arms have more than one mark, so make sure the right one is used. *Figure 12.1.*

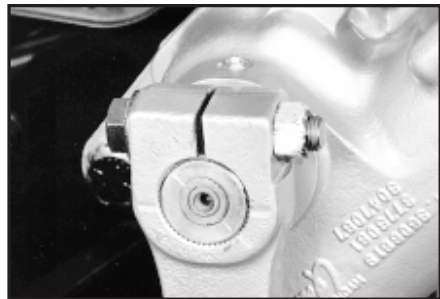

Figure 12.1

Test #13
Misadjusted Drag Link

The length of the drag link must be correct for the steering system. Check the length after you make sure the pitman arm/ shaft timing marks are aligned, the gear is at its center position, and the road wheels are straight ahead. *Figure 13.1.*

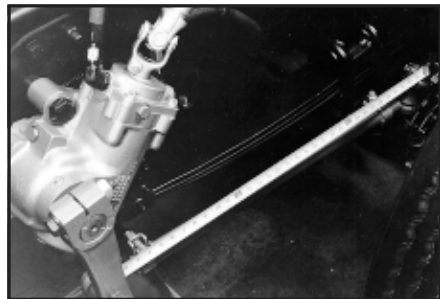

Figure 13.1

Test #14
Poppet Setting Procedure

1. If you are working on a newly-installed TAS steering gear, refer to the service manual to correctly set the poppets. If you are working on a steering gear, other than a TAS series, refer to the OEM's service manual for correct poppet setting instructions.
2. To set poppets on a TAS series gear using the adjustable service kit, refer to your steering gear service manual.

Test #15
Lash in Steering System

Two people are needed for this test. One person will slowly turn the steering wheel back and forth one-quarter turn each way from center with the engine idling. The other person should check for looseness at each of the following areas from steering wheel to road wheels: *Figures 15.1-15.5.*

- * Steering wheel to steering column
- * U-joints, or slip-joint and/or miter boxes
- * Steering column to steering gear input shaft
- * Steering gear input shaft to steering gear output shaft
- * Pitman arm to output shaft
- * Drag link to pitman arm connection
- * Drag link ends (sockets) and adjustable areas
- * Axle arm to drag link connection
- * King pin axle connections (bushings)
- * Tie rod arms to tie rod connection
- * Tie rod ends (sockets) and adjustable areas
- * Steering spindle
- * Wheel bearings
- * Lug nuts
- * Spring pin connectors
- * Front axle u-bolts
- * Spring hanger brackets/rear shackles

NOTE Cracked or broken components can cause symptoms similar to loose components but may be more difficult to find.

NOTE Be sure to check rear drive axles for any looseness and inspect tires for signs of abnormal wear.

Test #16
Steering Gear Adjustment

Check and adjust according to the appropriate service manual for your steering gear if necessary

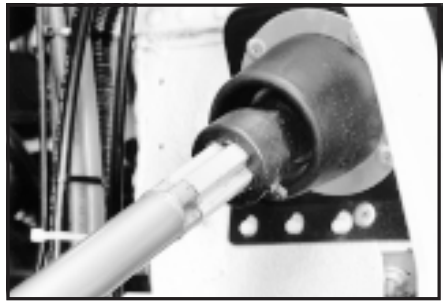

Figure 15.1

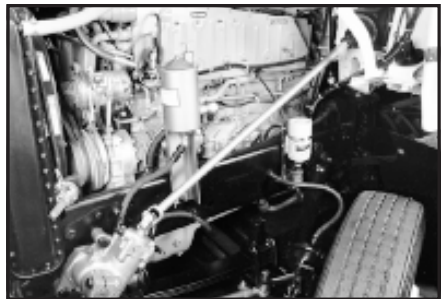

Figure 15.2



Figure 15.3

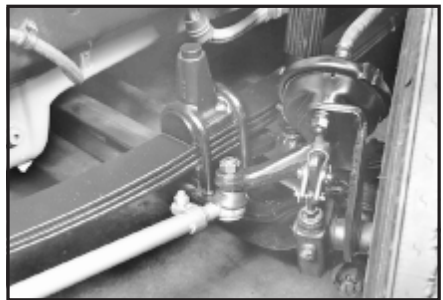

Figure 15.4



Figure 15.5

**Test #17****U-Joint Phasing and Lubrication**

1. Make sure u-joints are properly lubricated.
2. Steering column assemblies with more than one universal joint (cardan type) can cause a cyclic binding feel or torque variation at the steering wheel if the u-joints are not in phase with each other. *Figure 17.1-17.2.* If a steering column assembly with multiple u-joints is taken apart, it must be reinstalled with the timing marks for slip mechanisms aligned. This is true for both the cross-type and the splined-type two-piece intermediate shaft.

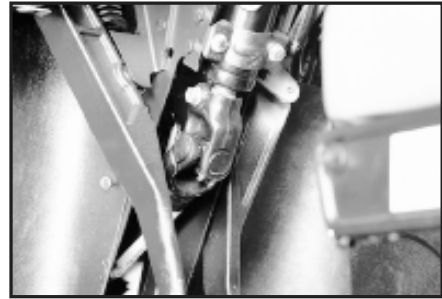

Figure 17.1

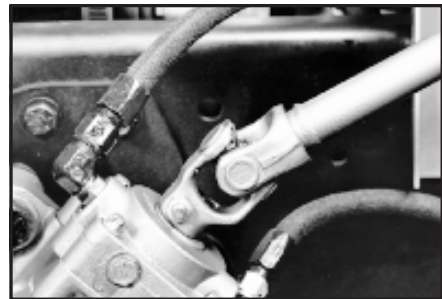

Figure 17.2

Test #18**Steering Column Interference**

Position steering wheel at the location where steering wheel interference is noticed, and look for something interfering or rubbing on the rotating column assembly such as brackets, bolts, floorboard, boot, etc.

Test #19**Intermediate Column Interference**

1. Check the slip column by looking to make sure there is proper travel allowance when in use. *Figure 19.1.*
2. Look for wear or galling. *Figure 19.2.*
3. Check slip column for too much slip force



Figure 19.1



Figure 19.2

**Test #20
Miter Box Misadjusted (if equipped)**

Check and adjust per manufacturer's instructions. *Figure 20.1.*



Figure 20.1

**Test #21
Vehicle Alignment**

Check alignment of steered axle and rear drive axles, and trailer axles (if problem only exists with trailer). *Figure 21.1.*

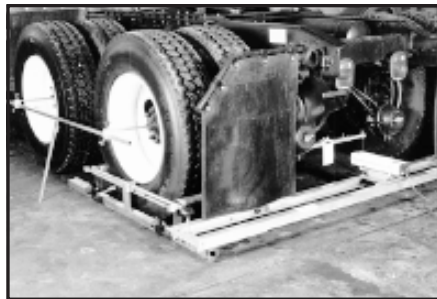

Figure 21.1

**Test #22
Wheel Bearing Adjustment**

Verify that adjustment is made according to manufacturer's specification. *Figure 22.1.*



Figure 22.1

**Test #23
Air Suspension Adjustment**

Check and set to manufacturer's specifications

**Test #24
Gear Imbalance**

1. Install a low pressure gauge (200-300 psi (14-21 bar) maximum with approximately 10 psi (.70 bar) per division) in the pressure line from pump to gear. *Figure 24.1.*

CAUTION Do not allow system pressure to exceed the rating of the gauge in the following procedure or damage to the gauge will result.

2. At engine idle, slightly turn the steering wheel one direction until a pressure rise is observed at the gauge. *Figure 24.2.*
3. Stop steering and gently allow the steering wheel to recenter.
4. Next slightly turn the steering wheel the opposite direction while observing the gauge and determine if pressure initially rises or falls with initiation of a turn.
5. Repeat test a few times in each direction.
6. If a consistent fall in pressure is associated with the initiation of a turn in one direction, the steering gear's control valve is unbalanced and needs to be replaced.

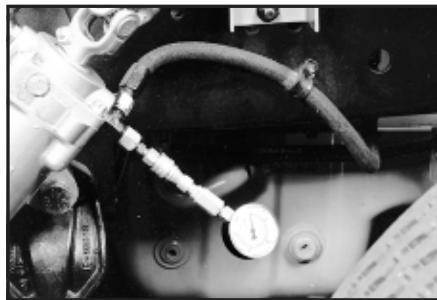

Figure 24.1

**Test #25
Unequal Brake Force**

Visually inspect brake assemblies for oil/grease on braking surfaces, and overall condition of brake surfaces. Adjust or replace brakes if necessary.



Figure 24.2

**Test #26****Tire Balance / Runout**

Have wheel assemblies balanced and checked for lateral and radial run out per manufacturer's specifications. Preferred method for checking balance is with wheels still on the vehicle. Balance includes total rotating assembly.

TEST #27**Steering Column Noise**

If column does not include a clockspring, remove steering wheel and add dielectric grease to the horn contact. The grease TRW uses is Model No. K-5/X Semifluid CA, product code 134613, from Century Lubricants. If noise continues, check steering wheel and shroud (not applicable to columns with clockspring).

TEST #28**Steering Column Bearing**

Check upper bearing gaskets. Gaskets should cover bearing.

TEST #29**Intermediate Column Lash**

Check intermediate column (I-Shaft) for torsional lash in U-Joints of slip section. Replace intermediate column if necessary.

This page intentionally left blank



Section 4 Comments

Comment A - H 36
Comment I - K..... 37



Comment A

Some power steering pumps have a temporary state during which the pumping element vanes do not extend. Usually increasing engine speed briefly will correct the problem.

Comment B

The maximum speed of steer with power assist for a power steering gear is limited by the pump flow and internal leakage. Example: Recommended minimum flow for a new TAS65 steering gear is 3.0 gpm (11.4 lpm), and is based on a maximum steering speed capability of 1.5 steering wheel turns per second.

Comment C

Vehicle linkages are designed to minimize the affect at the steering gear and steering wheel during normal steered axle/suspension movements. Be sure that linkage used is as specified by vehicle manufacturer.

Comment D

A single u-joint operating at an angle will cause a cyclic torque variation at the steering wheel. The amount of torque variation increases with the amount of operating angle. A secondary couple that side loads the input shaft also increases with increased u-joint angles. U-joint operating angles of 15 degrees or less will minimize the torque variation felt at the steering wheel.

Comment E

Deflections in the suspension and linkage, front and rear, due to high engine generated torque levels can cause a steering effect. This most often occurs at lower vehicle speeds while accelerating.

Comment F

The location of the axle arm ball center is important during spring wind-up conditions such as severe braking. A steering arm different from that specified by the manufacturer could cause a steering effect while braking.

Comment G

Soft or loosely supported rear suspensions may allow the rear driving axles to become non-square with the centerline of the chassis during load shifting or trailer roll which will tend to produce a steering effect.

Comment H

Power steering pump cavitation

Pump cavitation is defined as a "wining" or noisy power steering pump. Usually, pump cavitation is most noticed during engine start-up at low temperature extremes. However, other conditions can cause the power steering pump to continually cavitate and cause internal pump damage, and ultimately, failure. These conditions are:

1. Twisted, loose, or cracked inlet line
2. Inlet line blockage due to:
 - a. Contamination - dirt and foreign material
 - b. Damaged filters
 - c. Reservoir components
 - d. Inner hose liner separation
3. Displaced (improper or improperly installed) filters
4. Reservoir cap "vent" plugged

**Comment I**

Excessive Flow

TRW steering gears are rated for 8 gpm maximum power steering pump flow. Although the gears have the capability to handle this maximum flow, it is not always a system need or requirement. When using combinations of dual gears or a single gear with a hydraulic linear cylinder, supply flows for both components should be considered (See Steering Gear Flow Requirements). Single gear applications have a recommended flow at engine idle. For acceptable steering speed performance, again, refer to the Steering Gear Flow Requirements. Increasing the engine idle flow by more than 50% of the recommended flow can cause power steering system overheating, vehicle directional control problems (Darting), and steer axle returnability (Non-recovery). If you measure idle flows above the 50% limit, consult your OEM for guidance and recommendations.

Comment J

Flushing and Air Bleeding the System

IMPORTANT: Clean the area around the reservoir, steering gear and pump thoroughly before beginning this procedure.

1. Set parking brake on vehicle and block rear wheels.
2. Raise the front end off the ground
3. Take vehicle out of gear and put into neutral position
4. Raise hood and place a drip pan under the steering gear
5. Remove both the pressure and return lines from the steering gear
6. Remove filter from the power steering fluid reservoir and discard

IMPORTANT: Discard only the filter, other components may be required to hold filter element in place inside the reservoir.

7. Clean the inside of the reservoir
8. Turn steering wheel from full left to full right 3-4 times. This will purge the oil from the steering gear.
9. Reconnect pressure and return lines to the steering gear and tighten
10. Install new filter element into the reservoir
11. Clean reservoir filler cap with an approved solvent. Inspect gasket and replace if necessary.
12. Fill reservoir with approved replacement fluid and reinstall the filler cap
13. Start engine for 10 seconds, stop, and check reservoir fluid level and top off if necessary. You may need to repeat this procedure 3 or 4 times.
14. Upon completion of filling the reservoir, start the engine and let it idle. At engine idle, steer full right and full left once and return to straight ahead. Stop engine and check power steering reservoir level and top off if required.
15. Restart engine and steer full turns each direction 3 or 4 times.
16. Stop engine and recheck reservoir fluid level and adjust to correct level, if needed.
17. Inspect system for leaks and correct if necessary
18. Bleed air from the system if required (Refer to your steering gear service manual for recommended air bleeding procedures.)
19. Remove drip pan and lower vehicle. Remove blocks from wheels and release vehicle for normal service.

Comment K

Identifying "Burnt Oil"

Sometimes the power steering reservoir oil supply will become hotter than the normal operating temperature and overheat. This condition may result in an intermittent loss of power assist and also cause deterioration of the power steering hoses and component seals. TRW recommends that the power steering hoses be examined for deterioration due to overheated oil, which can be identified by wet hoses, and determine the condition of the reservoir fluid by looking for signs of "burnt oil."

This page intentionally left blank

900



Section 5 Test Results

Test 5 - Power Steering Pump Test	40
Test 5.1 - 40 Minute Power Steering Pump Test	40
Test 6 - Flow Control Response Test	41
Test 6.1 - 40 Minute Flow Control Response Test	41
Test 10 - Restricted Hydraulic Line Test	42
Steering Gear Flow Requirements	43
Pump Part Number Reference Guide	44



Test 5.0 - Power Steering Pump Test

Relief Pressure: _____ PSI/BAR

Engine(RPM)	No Load	1000PSI
Idle		
1500		

Table 5.0

Test 5.1 - 40 Minute Power Steering Pump Test

Ambient	
Start	
10 Minutes	
20 Minutes	
30 Minutes	
40 Minutes	
Unit of Measure	°F or °C

Relief Pressure: _____ PSI/BAR

Engine(RPM)	No Load	1000PSI
Idle		
1500		

Table 5.1



Test 6.0 - Pump Flow Control Response Test

Unit of Measure	PSI or BAR
Pump Relief #1 (Idle)	
Pump Relief #2 (Idle)	
Pump Relief #3 (Idle)	

Unit of Measure	PSI or BAR
Pump Relief #1 (1500 RPM)	
Pump Relief #2 (1500 RPM)	
Pump Relief #3 (1500 RPM)	

Table 6.0

Test 6.1 - 40 Minute Pump Flow Control Response Test

Ambient	
Start	
10 Minutes	
20 Minutes	
30 Minutes	
40 Minutes	
Unit of Measure	°F or °C

Unit of Measure	PSI or BAR
Pump Relief #1 (Idle)	
Pump Relief #2 (Idle)	
Pump Relief #3 (Idle)	

Unit of Measure	PSI or BAR
Pump Relief #1 (1500 RPM)	
Pump Relief #2 (1500 RPM)	
Pump Relief #3 (1500 RPM)	

Table 6.1

Test 10.0 - Restricted Hydraulic Line Test

With PSSA @ 125 - 135 F (52 - 57 C)	RPM	GPM or LPM
With pressure gauge at pressure line to steering gear at pump end	RPM	GPM or LPM
Remove pressure and return lines and measure pressure with gauge at pump outlet	RPM	PSI or BAR

Table 10.0



Steering Gear Flow Requirements

Single Gear

Gear	GPM	LPM
TAS40, THP/PCF45, HFB52	2.2	8.3
TAS55, THP/PCF60	2.6	9.8
TAS65 or HFB64	3.0	11.4
TAS85 or HFB70	3.6	13.6
RCS40	2.2	8.3
RCS55	2.6	9.8
RCS65	3.0	11.4
RCS85	3.6	13.6

Dual Gear

Gear	GPM	LPM
TAS65 w/ RCS65	6.0	22.7
TAS65 w/ Linear Cylinder	6.5	24.6
TAS85 w/ RCS85	7.0	26.5
TAS85 w/ RCS65	6.5	24.6
TAS85 w/ Linear Cylinder	6.5	24.6
HFB70 w/ RCB70	7.0	26.5
HFB70 w/ RCB64	6.5	24.6
HFB70 w/ Linear Cylinder	6.5	24.6

Pump Part Number Reference Guide

Check the part number on your TRW power steering pump and note the pump relief setting shown in the example below. (See illustration on where to find the pump part number). If the values that you have recorded are within +/- 100 psi (+/- 7 bar) your pump is functioning properly. If the values recorded are below the negative tolerance, your pump is malfunctioning and should be replaced.

For TRW power steering pumps, the relief setting will be the 5th and 6th numbers in the pump part number.

EV 18 12 15 R 1 01 00

Family designation _____

PS = PS Pump

EV = EV Pump

Displacement per revolution _____

18 = 18 cc (1.10 cir)

22 = 22 cc (1.34 cir)

25 = 25 cc (1.53 cir)

28 = 28 cc (1.71 cir)

Flow control _____

12 = 12 lpm (3.17 gpm)

14 = 14 lpm (3.70 gpm)

16 = 16 lpm (4.23 gpm)

20 = 20 lpm (5.28 gpm)

24 = 24 lpm (6.34 gpm)

Relief setting _____

09 = 90 bar (1305 psi)

10 = 100 bar (1450 psi)

12 = 120 bar (1740 psi)

14 = 140 bar (2030 psi)

15 = 150 bar (2175 psi)

16 = 160 bar (2320 psi)

17 = 170 bar (2465 psi)

18 = 185 bar (2683 psi)

Direction of rotation _____

R = clockwise rotation

L = counterclockwise rotation

Shaft type _____

1 = 11 tooth 16/32 spline

2 = .625 dia. woodruff key

Housing _____

Varies between PS and EV Series pump

Customer version _____

00 = Standard





TRW Automotive
Commercial Steering Systems
800 Heath Street
Lafayette, IN 47904
Tel 765.423.5377
Fax 765.429.1868
<http://www.trucksteering.com>
<http://trucksteering.trw.com>

© TRW Inc. 2002

TRW1250 Rev. 4/02

